

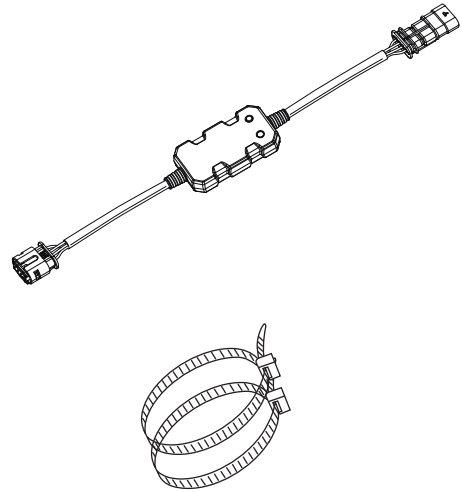

Quick Start Guide

AXON WARN® HUB RECEIVER

KIT CONTENTS



BEFORE YOU BEGIN

1.

Download the WARN® HUB App from the App Store or Google Play.



Data rates may apply.
Apple is a trademark of Apple Inc., registered in the U.S. and in other countries. App Store is a service mark of Apple Inc.
Google Play is a trademark of Google Inc.

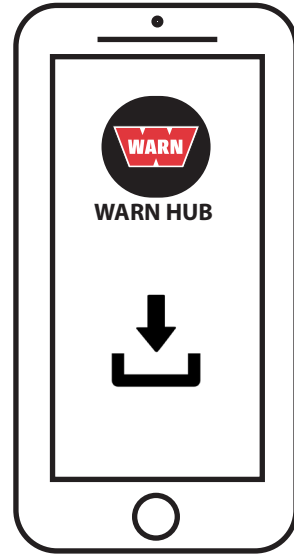

MOUNT



2.

Determine mounting location and wire routing path.
Recommendation: Under vehicle hood, on vehicle frame or along other wiring bundles. Avoid sharp edges, heat and moving parts.

3.

Using the included zip-ties, mount HUB Receiver firmly to vehicle.

4.

Route the plug ends of the HUB to the vehicle accessory wire harness connections. **NOTE: Make sure to route wires/cables away from sharp edges, heat and moving parts.**

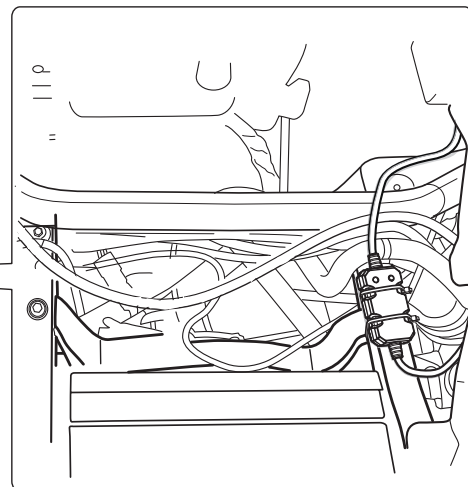

NOTE: Zip tie cables to vehicle in regular intervals to keep cables secure and in place.



Quick Start Guide

AXON WARN® HUB RECEIVER

WIRE

5.

- Disconnect the vehicle accessory wire harness from the winch control switch.
- Plug one HUB Receiver connector into the winch control switch.
- Plug remaining HUB Receiver connector into the accessory wire harness.

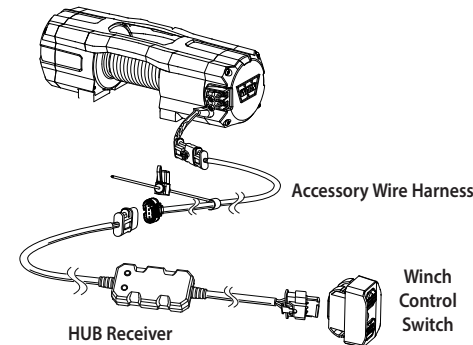

NOTE: Image shows HUB Receiver connection at switch. The HUB Receiver is also adaptable to winch connection if preferred.

POWER

6.

Turn vehicle power on.

NOTE: The HUB Receiver is active when the yellow light is on.

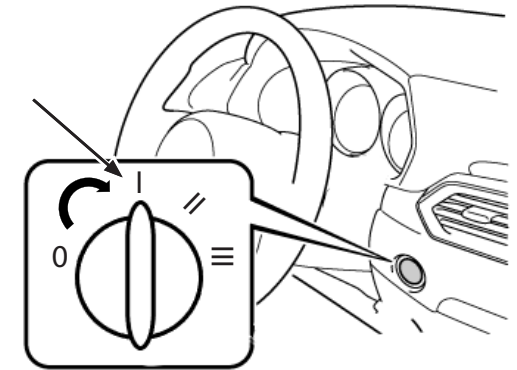
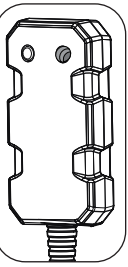

PAIR/CONNECT

7.

Press and hold button on HUB Receiver until blue light flashes (approximately 2 seconds) and then release button.

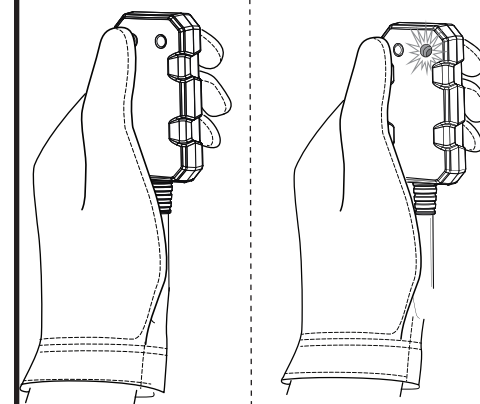

8.

Open app on phone and follow prompts.



9.

When light on the HUB Receiver turns green, you are connected.

Continue following the instructions through your app.

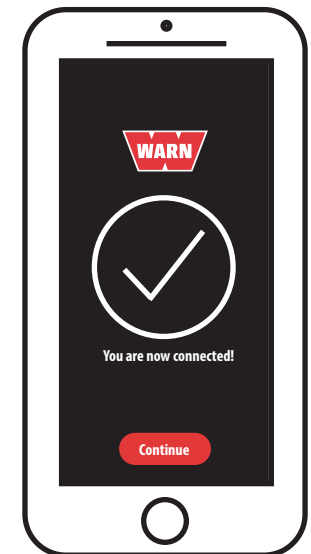
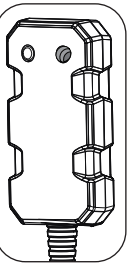

CUSTOMER SERVICE

WARN INDUSTRIES, INC. 12900 S.E. Capps Road,
Clackamas, OR USA 97015-8903, 1-503-722-1200
Customer Service: 1-800-543-9276
Dealer Locator Service: 1-800-910-1122



Guide de démarrage rapide

RÉCEPTEUR HUB WARN® AXON

CONTENU DU KIT

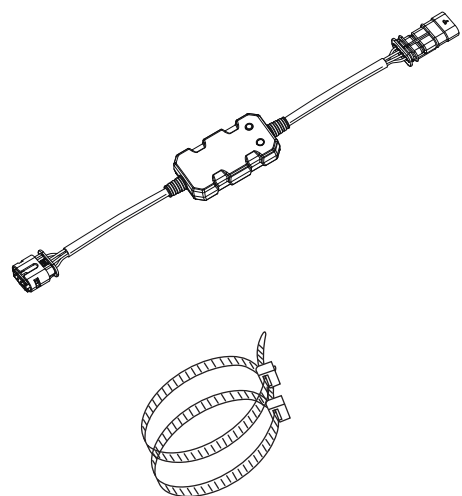

AVANT QUE TU COMMENCES

1.

Télécharger l'application HUB WARN® (application HUB) sur l'App Store ou Google Play.

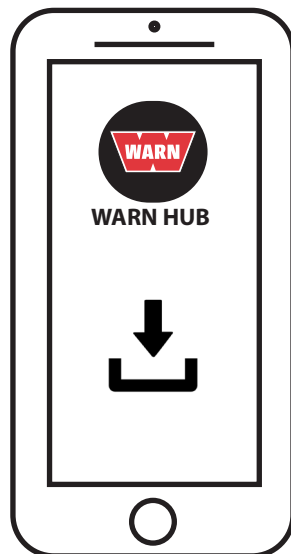

Les frais habituels de messagerie SMS et de transmission de données s'appliquent.
Apple est une marque de commerce d'Apple Inc., déposée aux États-Unis et dans d'autres pays. L'App Store est une marque de service d'Apple Inc.
Google Play est une marque de commerce de Google Inc.

MONTER



2.

Déterminer la position de montage et le cheminement des câbles.

Recommandation : sous le capot du véhicule, sur le châssis du véhicule ou le long des autres faisceaux de câbles. Éviter les bords tranchants, les sources de chaleur et les pièces mobiles.

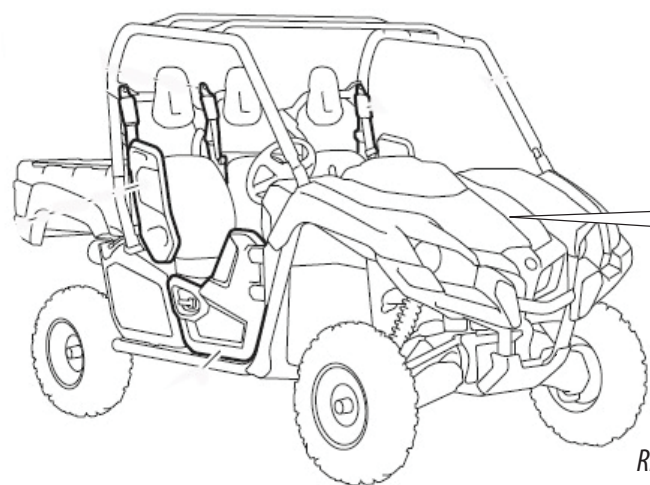

3.

Au moyen des serre-câbles fournis, monter le récepteur HUB fermement sur le véhicule.

4.

Acheminer les extrémités de la fiche du HUB jusqu'aux raccordements du faisceau de câbles de l'interrupteur. **REMARQUE :** veiller à acheminer les câbles en évitant les bords tranchants, les sources de chaleur et les pièces mobiles.

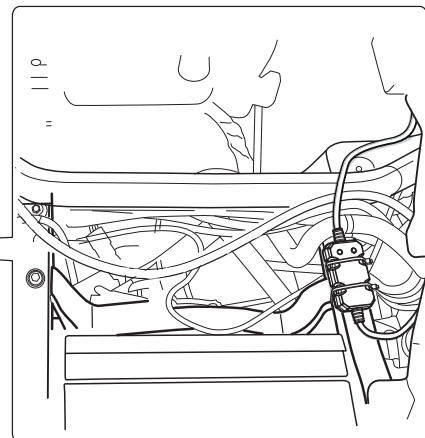

REMARQUE : fixer les câbles sur le véhicule au moyen des serre-câbles à intervalles réguliers afin qu'ils soient sécurisés et restent à leur place.



Guide de démarrage rapide

RÉCEPTEUR HUB WARN® AXON

INSTALLER

5.

- Débrancher le faisceau de câbles des accessoires du véhicule de l'interrupteur de commande de treuil.
- Brancher un connecteur du récepteur HUB sur l'interrupteur de commande de treuil.
- Brancher le connecteur du récepteur HUB restant sur le faisceau de câbles des accessoires.

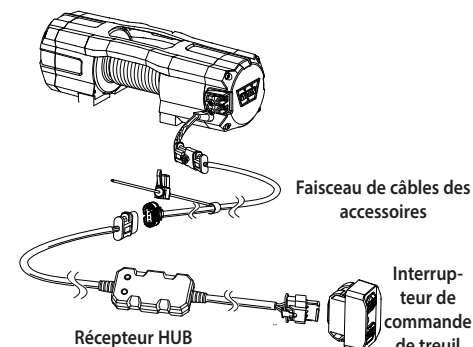

REMARQUE : l'illustration représente le branchement du récepteur HUB sur l'interrupteur. Le récepteur HUB peut également être adapté sur la connexion du treuil.

PUISSANCE

6.

Mettre le véhicule en marche.

REMARQUE : le récepteur HUB est activé si le voyant jaune est allumé.

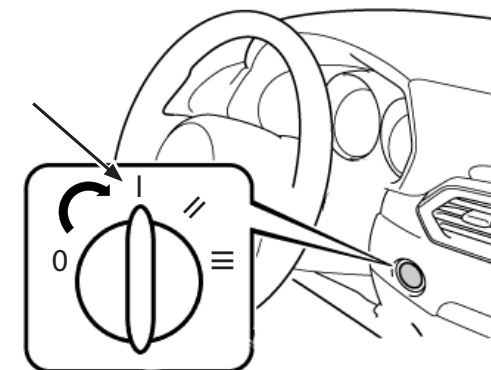
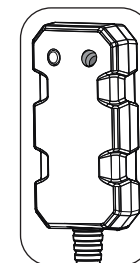

APPARIER/RELIER

7.

Appuyer sur le bouton du récepteur HUB jusqu'à ce que voyant bleu clignote (environ 2 secondes) et relâcher.

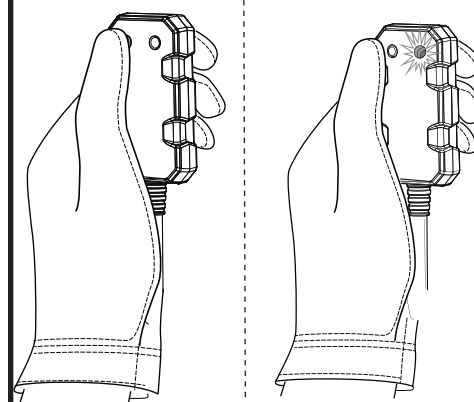

8.

Ouvrir l'application sur le téléphone et suivre les consignes.



9.

Lorsque le voyant du récepteur HUB devient vert, la connexion est établie. Continuer à suivre les consignes de l'application.

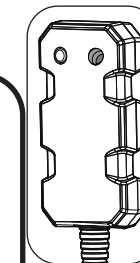

SERVICE CLIENTS

WARN INDUSTRIES, INC. 12900 S.E. Capps Road,
Clackamas, OR États-Unis 97015-8903, 1-503-722-1200
Service à la clientèle: 1-800-543-9276
Le Service de Locateur de négociant: 1-800-910-1122
www.warn.com



Guía de inicio rápido

RECEPTOR AXON WARN® HUB

CONTENIDO DEL KIT

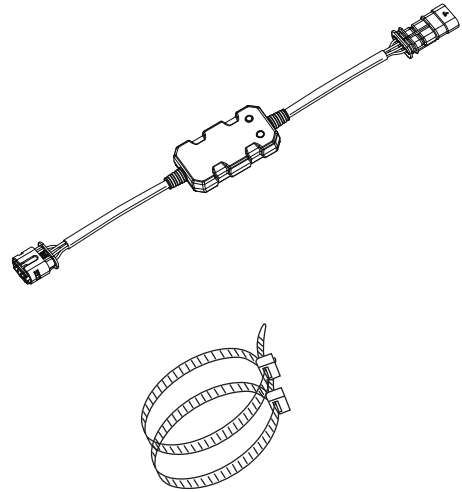

1.

Descargue la aplicación WARN® HUB (aplicación HUB) en la App Store o en Google Play.

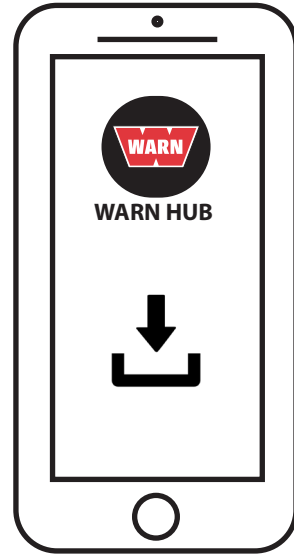

Pueden aplicarse tarifas de mensajes y datos
Apple es una marca comercial de Apple Inc. registrada en EE. UU. y otros países. App Store es una marca de servicio de Apple Inc.
Google Play es una marca comercial de Google Inc

ANTES DE QUE EMPIECES

MONTAR



2.

Determine la ubicación de montaje y la ruta de enrutamiento de los cables.

Recomendación: Debajo del capó del vehículo, en el bastidor del vehículo o a lo largo de otros haces de cables. Evite los bordes afilados, el calor y las piezas móviles. **Recommendation:**

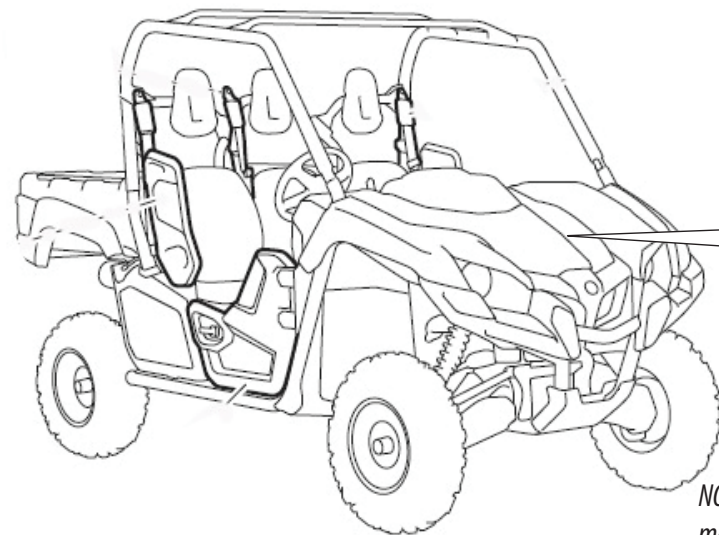

3.

Con las bridas incluidas, monte el receptor HUB en el vehículo con firmeza.

4.

Pase los extremos del cable del HUB hasta las conexiones del arnés del interruptor. **NOTA:** Asegúrese de mantener los cables alejados de bordes afilados, calor y piezas móviles.

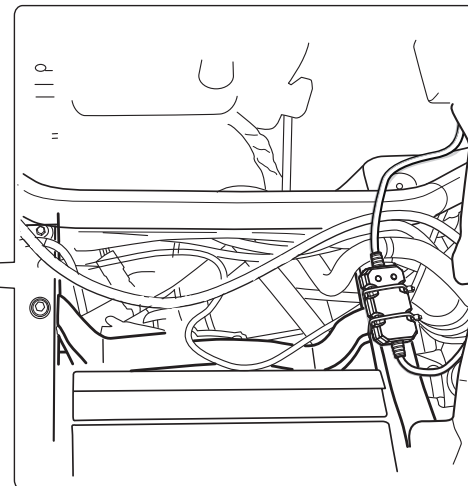

NOTA: Fije los cables al vehículo con una brida en intervalos regulares para mantenerlos seguros y bien posicionados.



Guía de inicio rápido

RECEPTOR AXON WARN® HUB

ALAMBRAR

5.

- Desconecte el arnés de cables accesorio del vehículo del interruptor de control del cabestrante.
- Conecte un conector del receptor HUB al interruptor de control del cabestrante.
- Conecte el conector del receptor HUB restante en el arnés de cables accesorio.

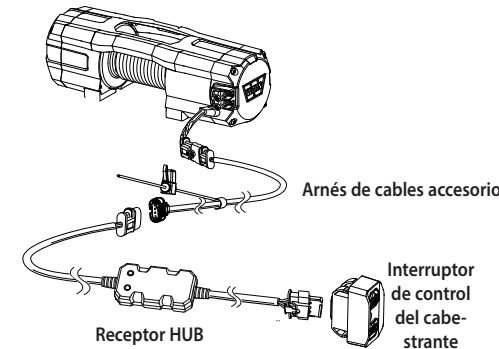

NOTA: La imagen muestra la conexión del receptor HUB en el interruptor. El receptor HUB también puede adaptarse a la conexión del cabestrante si lo prefiere.

ENERGÍA

6.

Encienda la batería del vehículo.

NOTA: Si aparece una luz amarilla, el receptor HUB está activo.

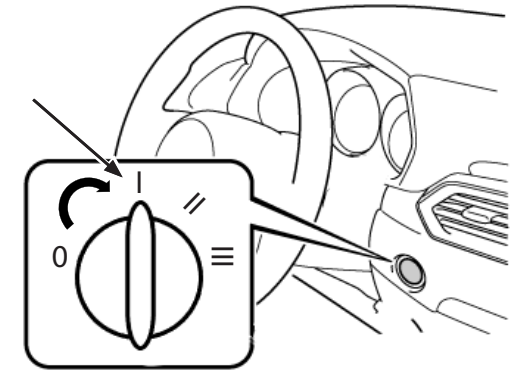
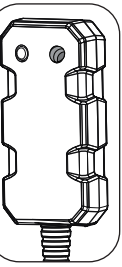

EMPAREJAR/CONECTAR

7.

Mantenga pulsado el botón del receptor HUB solo hasta que la luz azul parpadee (2 segundos aproximadamente) y luego suéltelo.

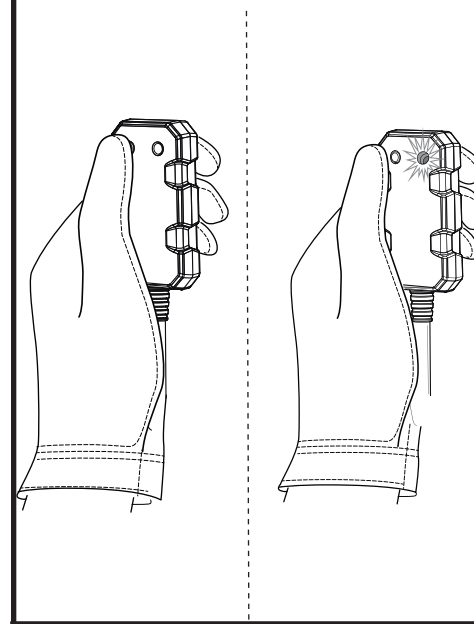

8.

Abra la aplicación en el teléfono y siga las instrucciones.



9.

Cuando la luz del receptor HUB cambie a verde significará que está conectado.

Continúe siguiendo las instrucciones a través de la aplicación.

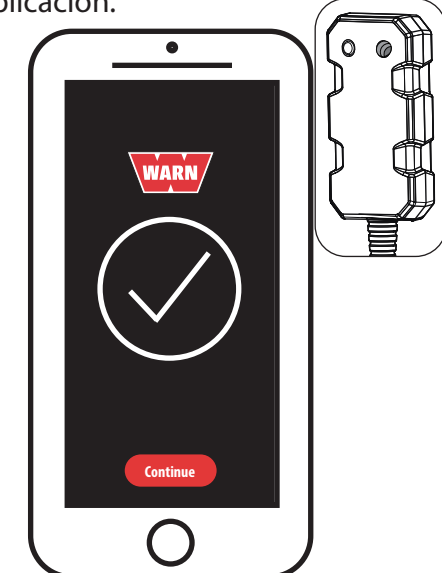

SERVICIO AL CLIENTE

WARN INDUSTRIES, INC. 12900 S.E. Capps Road,
Clackamas, OR EE.UU. 97015-8903, 1-503-722-1200
Servicio de atención al cliente: 1-800-543-9276
Servicio de Localizador de comerciante: 1-800-910-1122
www.warn.com



Kurzanleitung

AXON WARN® HUB-EMPFÄNGER



Kurzanleitung

AXON WARN® HUB-EMPFÄNGER

KIT INHALT

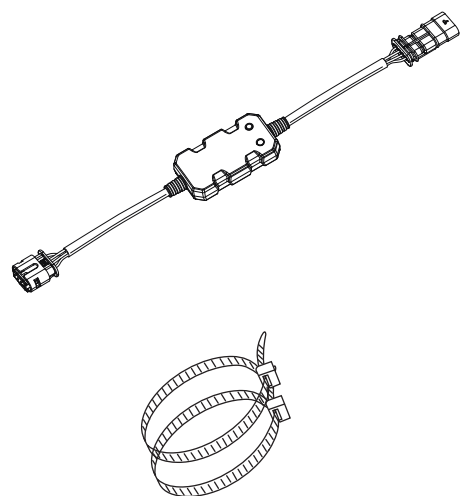

BEVOR SIE BEGINNEN

1.

Laden Sie die WARN® HUB App (HUB App) aus dem App Store oder aus Google Play herunter.

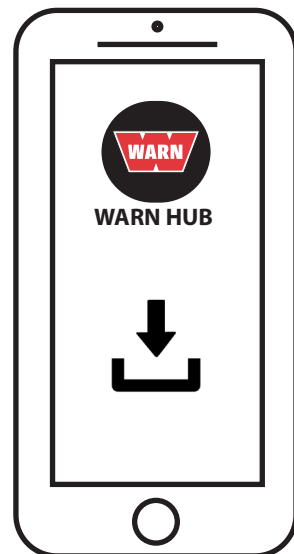

Es können SMS- und Datenübertragungsgebühren anfallen.
Apple ist eine Marke von Apple Inc., eingetragen in den USA und in anderen Ländern. App Store ist eine Dienstleistungsmarke von Apple Inc.
Google Play ist eine Marke von Google Inc.

MONTIEREN



2.

Bestimmen Sie die Montagestelle und eine Route für die Kabelverlegung.

Empfehlung: unter der Motorhaube des Fahrzeugs, an der Fahrzeugkarosserie oder entlang anderer Kabelstränge. Meiden Sie scharfe Kanten, Hitze und bewegliche Teile.

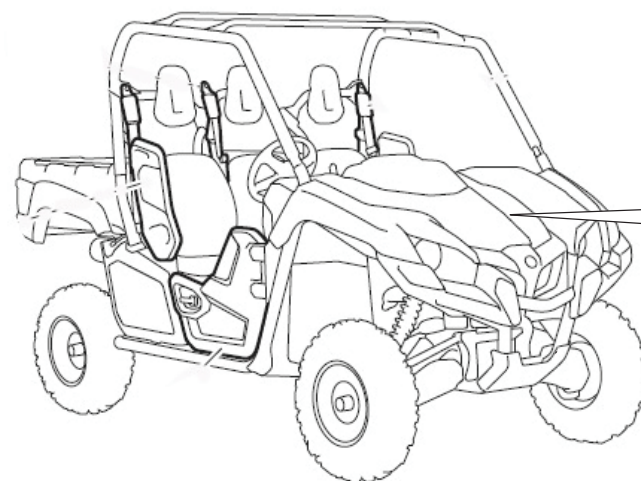

3.

Befestigen Sie den HUB-Empfänger mit den mitgelieferten Kabelbindern sicher am Fahrzeug.

4.

Verlegen Sie die Stecker des HUB zu den Anschlüssen des Schalterkabelbaums. **HINWEIS:** achten Sie darauf, Drähte/Kabel von scharfen Kanten, Hitze und beweglichen Teilen fernzuhalten.

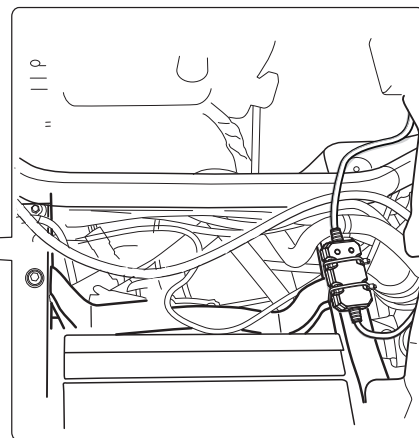

HINWEIS: bringen Sie in regelmäßigen Abständen Kabelbinder am Fahrzeug an, um die Kabel zu sichern.

VERDRAHTEN

5.

- Trennen Sie den Zubehörcabelbaum des Fahrzeugs vom Steuerungsschalter der Winde.
- Schließen Sie einen Stecker des HUB-Empfängers am Steuerungsschalter der Winde an.
- Schließen Sie den verbleibenden Stecker des HUB-Empfängers am Zubehörcabelbaum an.

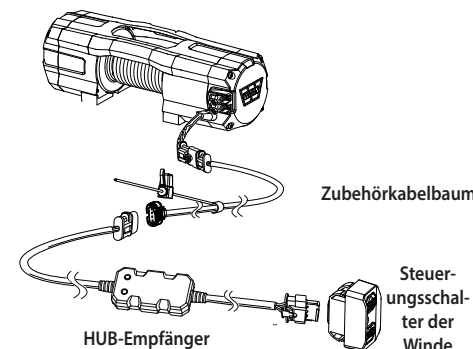

HINWEIS: die Abbildung zeigt die Verbindung des HUB-Empfängers am Schalter. Der HUB-Empfänger ist auf Wunsch auch an den Windenanschluss anpassbar.

LEISTUNG

6.

Schalten Sie die Stromversorgung des Fahrzeugs ein.

HINWEIS: die gelbe Leuchte zeigt an, dass der HUB-Empfänger aktiv ist.

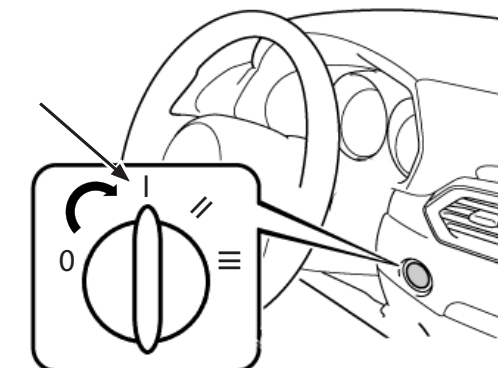
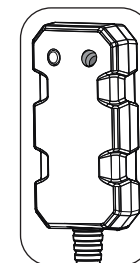

PAAR/VERBINDEN

7.

Halten Sie die Taste am HUB-Empfänger gedrückt, bis die Leuchte blau blinkt (ungefähr zwei Sekunden). Lassen Sie die Taste dann los.

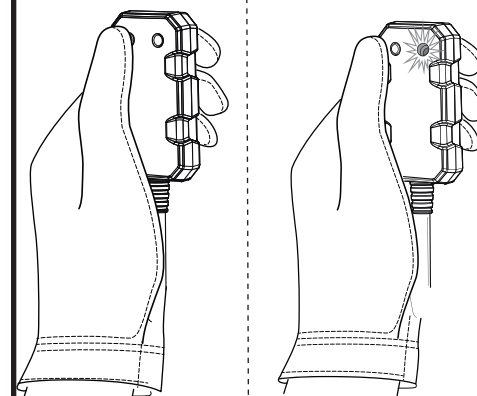

8.

Öffnen Sie die App auf dem Smartphone und befolgen Sie die Anweisungen.



9.

Wenn die Leuchtanzeige am HUB-Empfänger grün wird, sind Sie verbunden.

Befolgen Sie weiter die Anweisungen in Ihrer App.

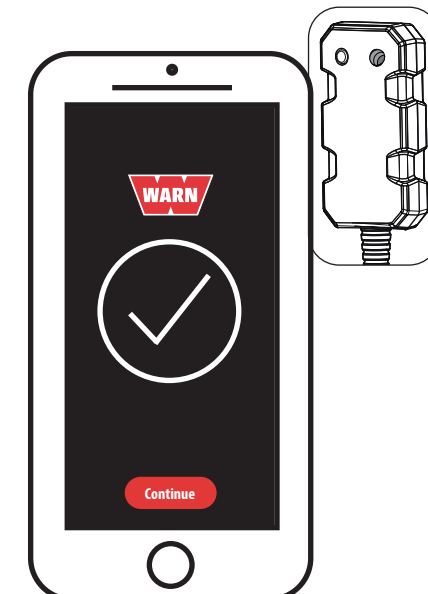

KUNDENDIENST

WARN INDUSTRIES, INC. 12900 S.E. Capps Rd.
Clackamas, OR USA 97015-8903, 1-503-722-1200
Kundendienst: 1-800-543-9276
Händlersuche: 1-800-910-1122
www.warn.com



Snabbstartsguide

AXON WARN® HUB-MOTTAGARE

KIT INNEHÅLL

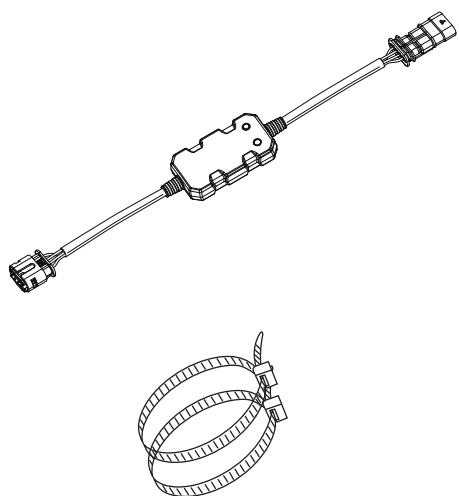

INNAN DU BÖRJAR

1.

Ladda ner WARN® HUB-appen (HUB-appen) från App Store eller Google Play.

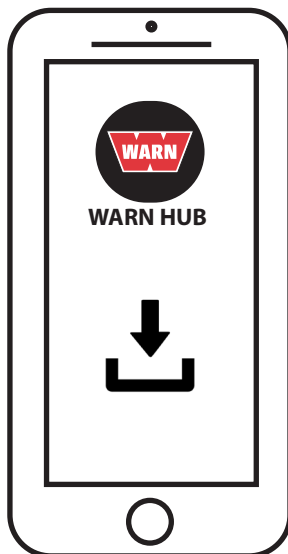

Meddelande- och dataavgifter kan tillkomma

Apple är ett varumärke som tillhör Apple Inc., registrerat i USA och i andra länder. App Store är ett servicemärke som tillhör Apple Inc.

Google Play är ett varumärke som tillhör Google Inc.

MONTERA



2.

Bestäm monteringsplats och ledningsväg.

Rekommendation: Under fordonshuven, på fordonshuven eller längs andra kabelförpackningar.

Undvik vassa kanter, värme och rörliga delar.

3.

Använd de medföljande buntbanden och montera HUB-mottagaren ordentligt på fordonet.

4.

Dra pluggändarna på HUB till brytarens kablage.
OBSERVERA: Se till att leda ledningar/kablar bort från vassa kanter, värme och rörliga delar.

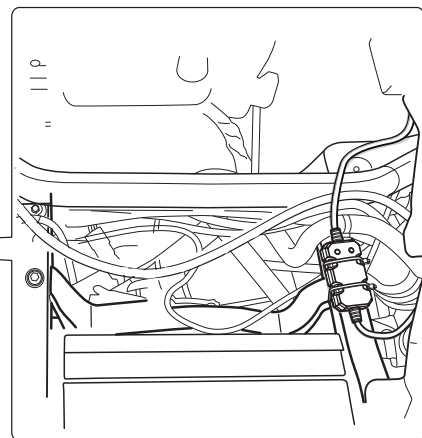
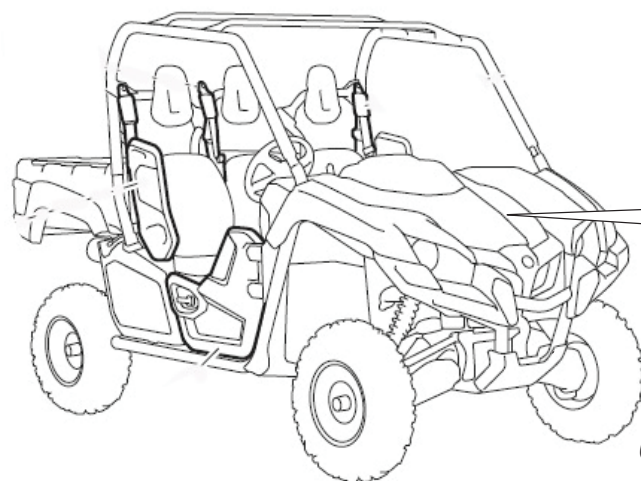

OBSERVERA: Använd buntband för att fästa kablarna till fordonet med jämna mellanrum för att hålla kablarna säkra och på plats.



Snabbstartsguide

AXON WARN® HUB-MOTTAGARE

TRÅD

5.

- Koppla bort bilens tillbehörskablage från vinschens reglage.
- Anslut en HUB-mottagarkontakt till vinschens reglage.
- Anslut återstående HUB-mottagaranslutning till tillbehörskablagen.

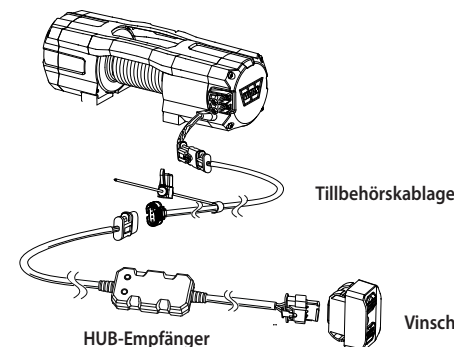

OBSERVERA: Bilden visar HUB-mottagaranslutning vid brytaren. HUB-mottagaren kan också anpassas till vinschanslutning om det föredras. Windenanslutning anpassbar.

EFFEKT

6.

Slå på fordonets ström.

OBSERVERA: HUB-mottagaren är aktiv när den gula lampan lyser.

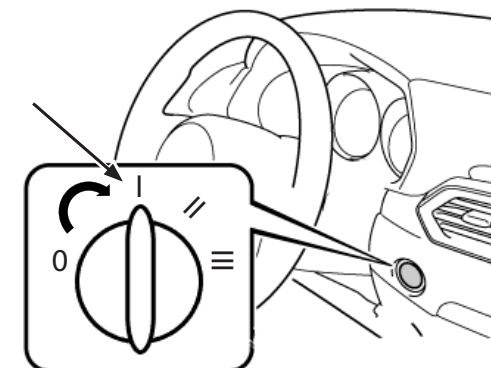
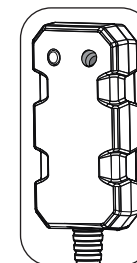

PARA/ANSLUTA

7.

Tryck ned knappen på HUB-mottagaren tills den blå lampan blinkar (cirka 2 sekunder) och släpp sedan knappen.

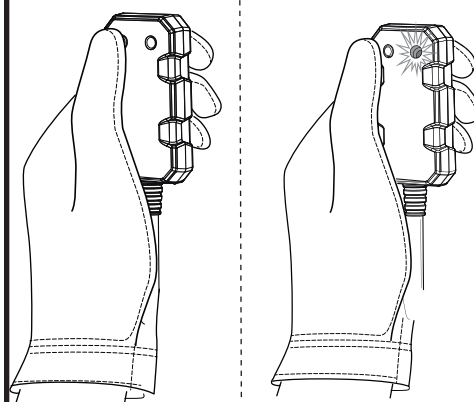

8.

Öppna appen på telefonen och följ anvisningarna.



9.

När lampan på HUB-mottagaren blir grön är du ansluten.

Fortsätt följa instruktionerna genom din app.

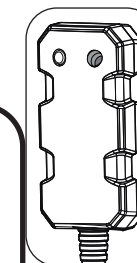

KUNDSERVICE

WARN INDUSTRIES, INC. 12900 S.E. Capps Road,
Clackamas, OR USA 97015-8903, 1-503-722-1200
Kundtjänst: 1-800-543-9276
Återförsäljare: 1-800-910-1122
www.warn.com



Guida di avvio rapido

RICEVITORE HUB WARN® AXON

CONTENUTO DEL KIT

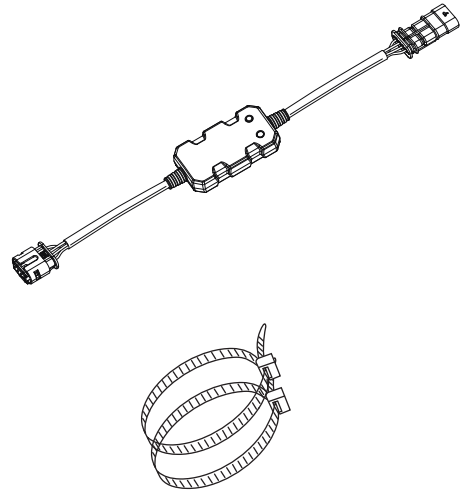

PRIMA DI INIZIARE

1.

Scaricare l'app HUB WARN® (app HUB) da App Store o Google Play.

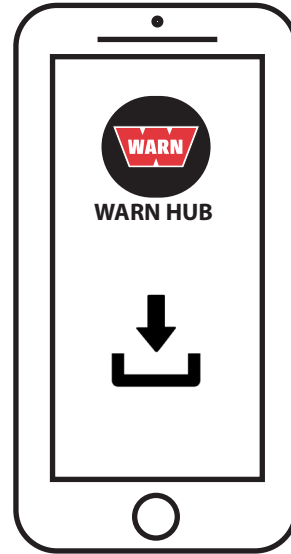

Potrebbero essere applicate tariffe per dati e messaggi

Apple è un marchio di fabbrica di Apple Inc., registrato negli Stati Uniti e in altri paesi. App Store è un marchio di servizio di Apple Inc.

Google Play è un marchio di fabbrica di Google Inc.

MONTARE



2.

Stabilire la posizione di installazione e il percorso di instradamento del cavo.

Consiglio: sotto il cofano del veicolo, sul telaio del veicolo o lungo altri fasci di cavi. Evitare spigoli vivi, fonti di calore e parti in movimento.

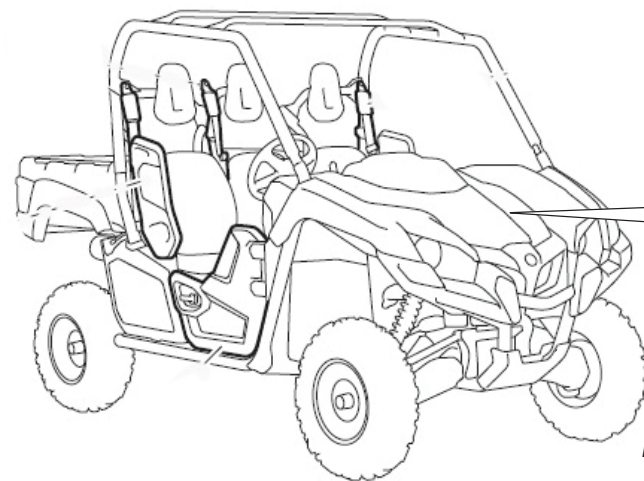

3.

Utilizzando le fascette in dotazione, fissare saldamente il ricevitore HUB al veicolo.

4.

Dirigere i contatti della spina del ricevitore HUB verso i collegamenti del cablaggio dell'interruttore. **NOTA:** assicurarsi di tenere lontani i conduttori e i cavi da spigoli vivi, fonti di calore e parti in movimento.

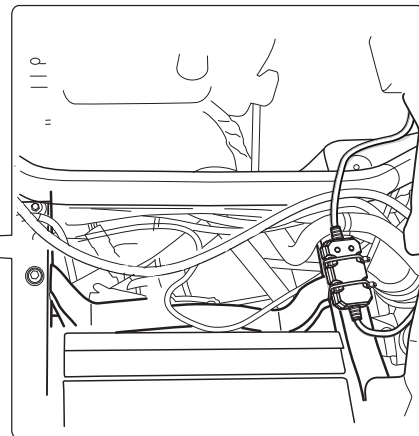

NOTA: fissare con le fascette i cavi al veicolo a intervalli regolari per mantenerli saldamente in sede.



Guida di avvio rapido

RICEVITORE HUB WARN® AXON

CABLARE

5.

- Scollegare il cablaggio accessorio del veicolo dall'interruttore di comando del verricello.
- Collegare un connettore del ricevitore HUB all'interruttore di comando del verricello.
- Collegare l'altro connettore del ricevitore HUB al cablaggio accessorio.

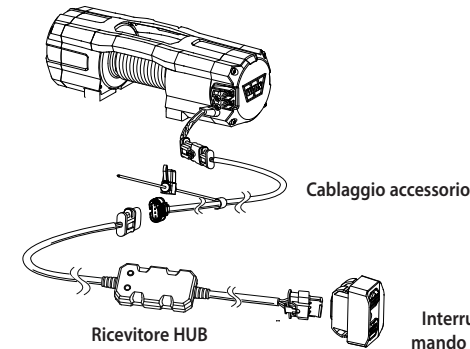

NOTA: la figura mostra il collegamento del ricevitore HUB all'interruttore. È possibile anche adattare il ricevitore HUB per il collegamento del verricello.

LAELETTRICITÀ

6.

Accendere l'alimentazione del veicolo. **NOTA:** il ricevitore HUB è attivo quando la spia gialla è accesa.

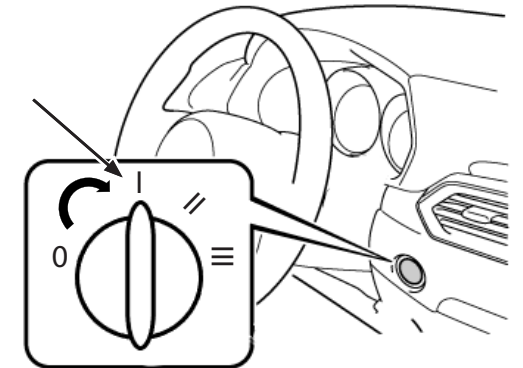
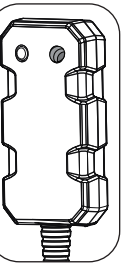

ACCOPIRIE/COLLEGARE

7.

Premere e tenere premuto il tasto sul ricevitore HUB finché la spia blu non lampeggia (circa 2 secondi), poi rilasciarlo.

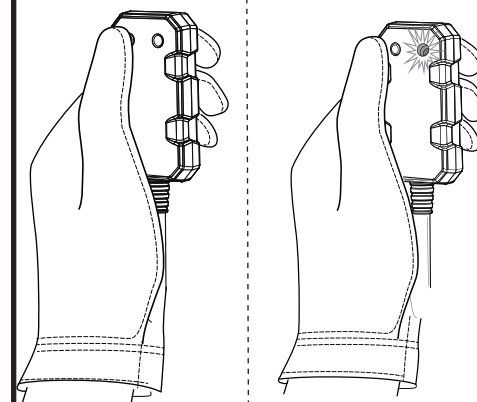

8.

Aprire l'app sul telefono e seguire le istruzioni.



9.

Quando la spia sul ricevitore HUB diventa verde, la connessione è attiva.

Continuare a seguire le istruzioni dell'app.

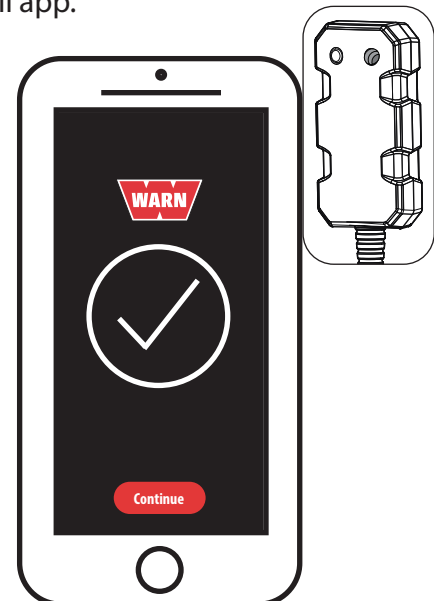

ASSISTENZA CLIENTI

WARN INDUSTRIES, INC. 12900 S.E. Capps Road,
Clackamas, OR USA 97015-8903, 1-503-722-1200
Servizio clienti: 1-800-543-9276
Servizio di localizzazione dei rivenditori: 1-800-910-1122
www.warn.com



Guia rápido

RECEPTOR HUB WARN® PARA AXON

CONTEÚDO DO KIT

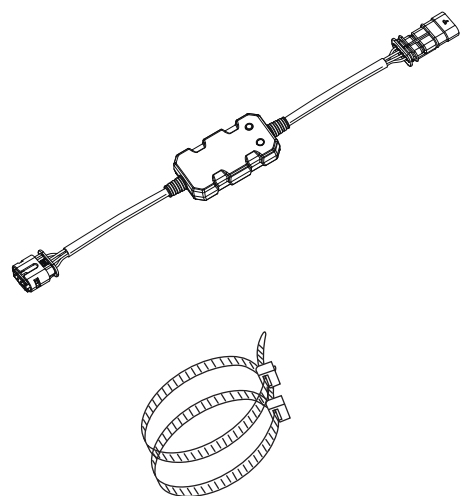

ANTES DE VOCÊ COMEÇAR

1.

Faça o download do aplicativo HUB WARN® (Aplicativo HUB) da App Store ou do Google Play.

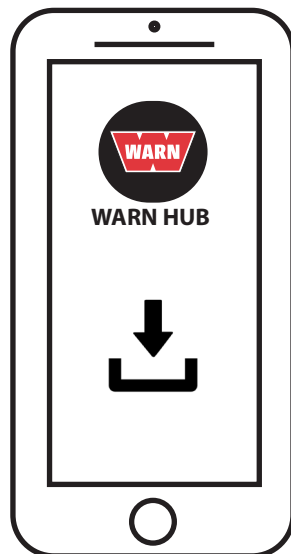

Podem ser aplicadas taxas de mensagens e dados
Apple é uma marca registrada da Apple Inc., nos EUA e em outros países. App Store é uma marca de serviço da Apple Inc.
Google Play é uma marca registrada da Google Inc.

MOUNT



2.

Determine o local de montagem e o encaminhamento do cabo.

Recomendação: embaixo do capô, no chassi do veículo ou em outra fiação. Evite pontas afiadas, calor e peças móveis.

3.

Usando as abraçadeiras incluídas, monte firmemente o receptor HUB ao veículo.

4.

Encaminhe as extremidades do plugue do HUB para as conexões do chicote do interruptor. **OBSERVAÇÃO:** certifique-se de encaminhar os fios/cabos longe de pontas afiadas, calor e peças móveis.

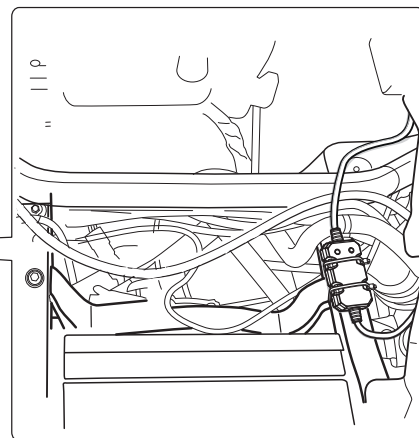
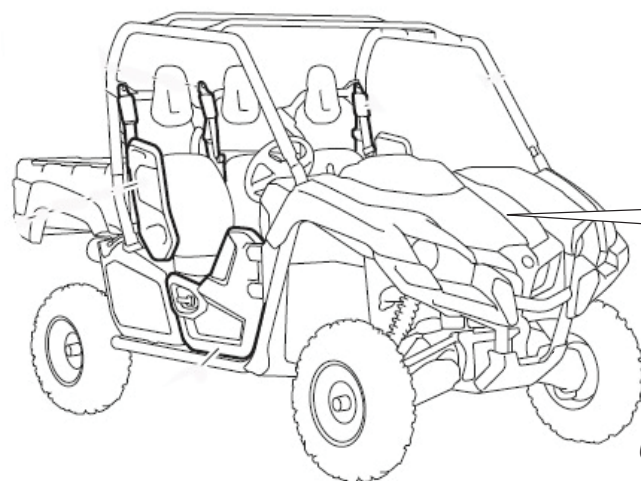

OBSERVAÇÃO: prenda os cabos ao veículo com as abraçadeiras em intervalos regulares, para mantê-los seguros e no lugar.



Guia rápido

RECEPTOR HUB WARN® PARA AXON

FIO

5.

- Desconecte a amarração de cabo acessória do veículo do interruptor do controle do guincho.
- Ligue o conector do receptor HUB no interruptor do controle do guincho.
- Ligue o conector do receptor HUB restante na amarração de cabo acessória.

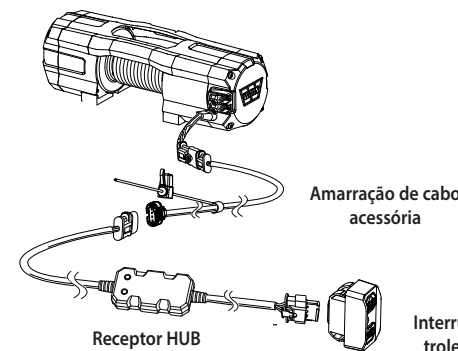

OBSERVAÇÃO: a imagem exibe a conexão do receptor HUB ao interruptor. Se preferir, o receptor HUB também pode ser adaptado à conexão do guincho.

VIGOR

6.

Ligue o veículo. **OBSERVAÇÃO:** O receptor HUB está ativo quando a luz amarela está acesa.

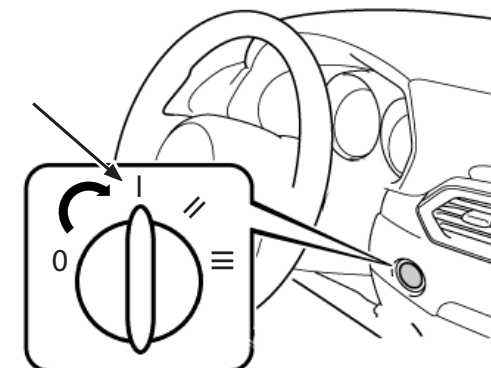
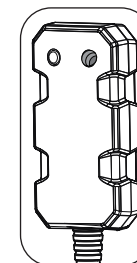

ACASALAR/CONECTAR

7.

Pressione e segure o botão no receptor HUB até que a luz azul pisque (aproximadamente dois segundos) e depois solte.

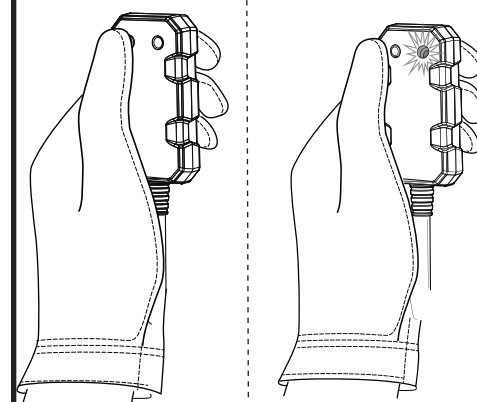

8.

Abra o aplicativo no telefone e siga as instruções.



9.

Quando a luz no receptor HUB fica verde, significa que está conectado. Siga as instruções no aplicativo.

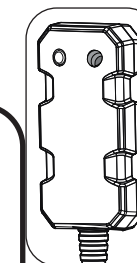

SERVIÇO AO CLIENTE

WARN INDUSTRIES, INC. 12900 S.E. Capps Road,
Clackamas, OU EUA 97015-8903, 1-503-722-1200
Serviço ao Cliente: 1-800-543-9276
Serviço de Localizador de Revendedores: 1-800-910-1122
www.warn.com



PIKAOPAS

AXON WARN® HUB -VASTAANOTIN

PAKKAUKSEN SISÄLTÖ

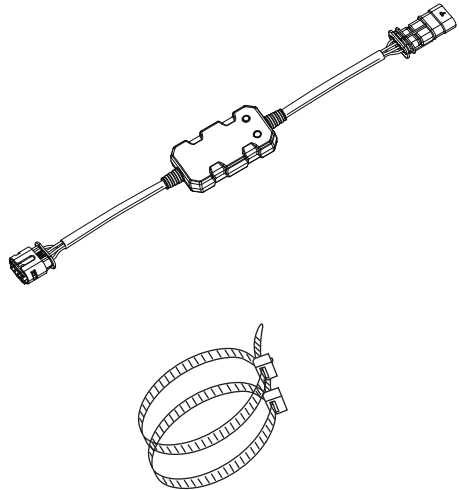

1.

Lataa WARN® HUB -sovellus (HUB-sovellus) App Storesta tai Google Playsta.

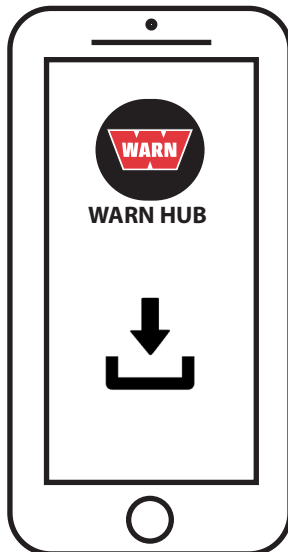

Viestien ja datan hinta saattaa vaihdella.

Apple on Apple Inc:n Yhdysvalloissa ja muissa maissa rekisteröimä tavaramerkki. App Store on Apple Inc:n palvelumerkki.

Google Play on Google Inc:n tavaramerkki.

ENNEN KUIN ALOITAT

ASENTAA



2.

Määritä asennuskohta ja johtojen reitti.

Suositus: Ajoneuvon konepellin alle, ajoneuvon koriin tai muiden johdotusten kanssa. Vältä teräviä reunoja, kuumuutta ja liikkuvia osia.

3.

Kiinnitä HUB-vastaanotin mukana toimitetuilla nippusiteillä tukevasti ajoneuvoon.

4.

Ohjaa vinssin etäpistokkeen pää ajoneuvon säleikön taakse ja kohti vinssin etäpistorasiaa. **HUOMAUTUS:** Varmista, että johdot ja kaapelit ohjataan pois päin terävistä reunoista, kuumuudesta ja liikkuvista osista.

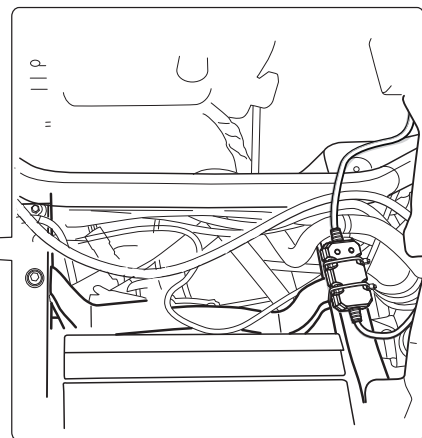
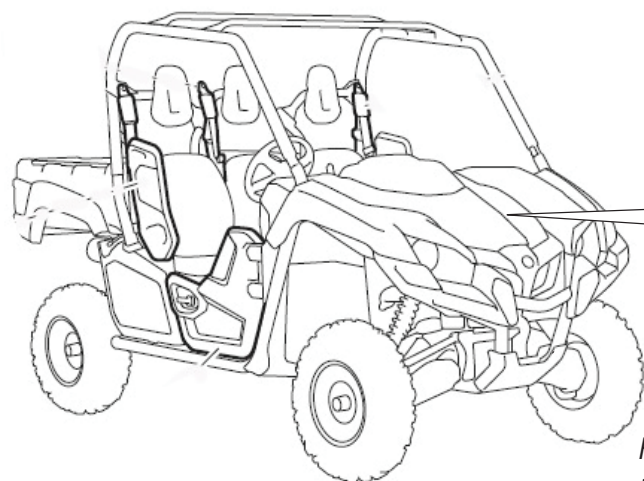

HUOMAUTUS: Kiinnitä kaapelit ajoneuvoon nippusiteillä säännöllisin välein tiukasti paikoilleen.



PIKAOPAS

AXON WARN® HUB -VASTAANOTIN

JOHDOTTAA

5.

- Irrota ajoneuvon lisävarusteen johdinnippu vinssin ohjauskytkimestä.
- Kytke yksi HUB-vastaanottimen liitin vinssin ohjauskytkimeen.
- Kytke jäljellä oleva HUB-vastaanottimen liitin lisävarusteen johdinnippuun.

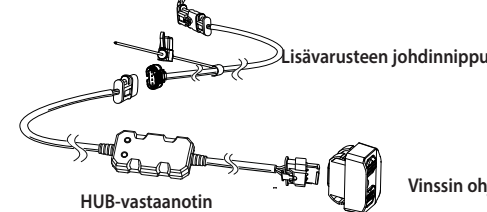
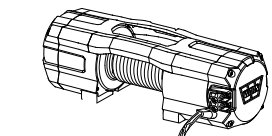

HUOMAUTUS: Kuvassa näkyy HUB-vastaanottimen liitos kytkimessä. HUB-vastaanotin voidaan haluttaessa liittää myös vinssiin.

ENERGIA

6.

Käynnistä ajoneuvo.

HUOMAUTUS: HUB-vastaanotin on aktiivinen, kun keltainen valo palaa.

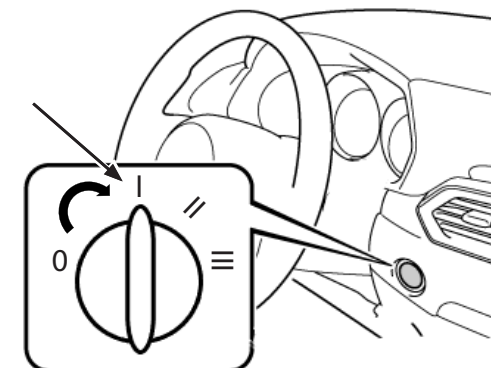
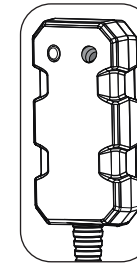

JÄRJESTYÄ PAREITTAIN/LIITTÄÄ YHTEEN

7.

Pidä HUB-vastaanottimen painiketta painettuna, kunnes sininen valo vilkkuu (noin kaksi sekuntia), ja sitten vapauta se.

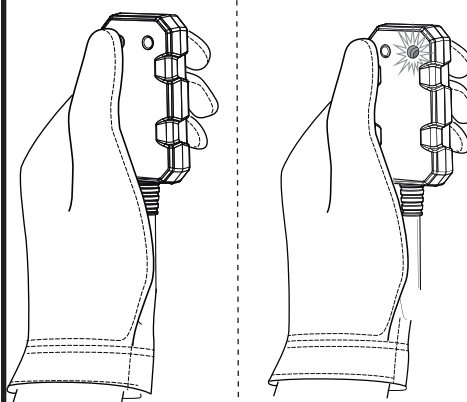

8.

Avaa sovellus puhelimesa ja noudata kehoitteita.



9.

Kun HUB-vastaanottimen valo muuttuu vihreäksi, yhteys on muodostettu.

Jatka sovelluksessa esitettyjen ohjeiden mukaisesti.

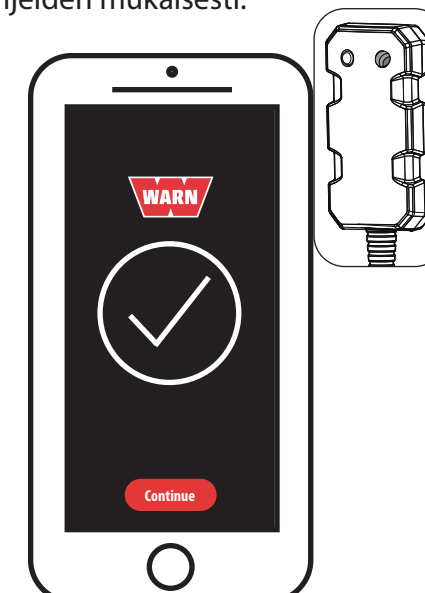

ASIAKASPALVELU

WARN INDUSTRIES, INC. 12900 S.E. Capps Road,
Clackamas, OR USA 97015-8903, 1-503-722-1200
Asiakaspalvelu: 1-800-543-9276
Jälleenmyyjähakupalvelu: 1-800-910-1122
www.warn.com



SNELSTARTGIDS

AXON WARN® HUB-ONTVANGER

INHOUD VAN DE SET

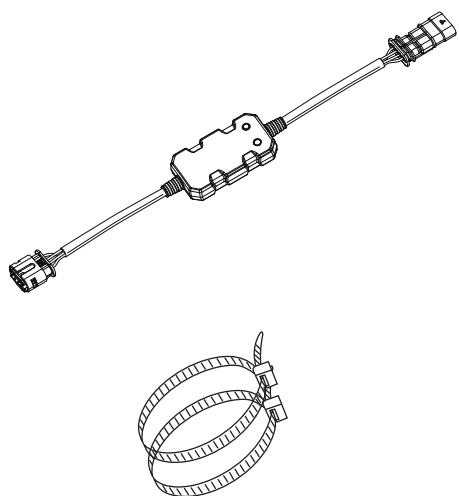

VOORDAT JE BEGINT

1.

Download de WARN® HUB-app (HUB-app) in de App Store of Google Play.

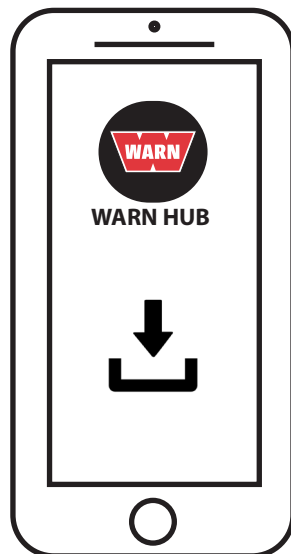

Mogelijk brengt je provider sms- en datakosten in rekening
App Store is een handelsmerk van Apple Inc., gedeponeerd in de VS en andere landen. App Store is een servicemerk van Apple Inc.
Google Play is een handelsmerk van Google Inc.

MONTEREN



2.

Bepaal montageplaats en de route van de bedrading.

Aanbeveling: Onder de voertuigkap, op het frame van het voertuig of naast andere bedradingen. Vermijd scherpe randen, hete en bewegende onderdelen.

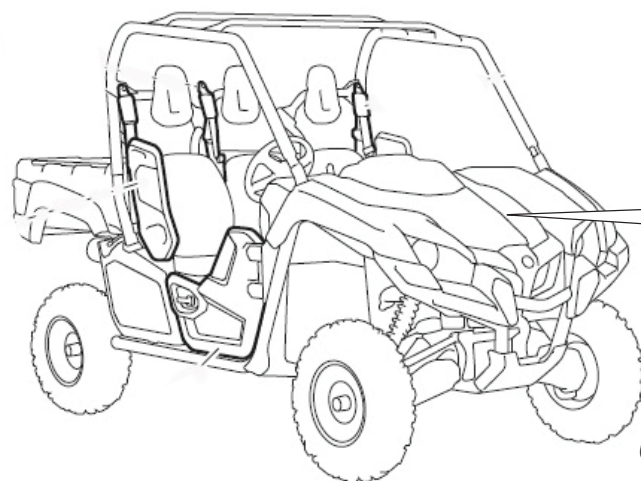

3.

Monteer de HUB-ontvanger stevig aan het voertuig met behulp van de meegeleverde kabelbinders.

4.

Leid de plugeinden van de HUB naar de kabelboomverbindingen van de schakelaar. **OPMERKING:** Verifieer dat draden/kabels niet worden geleid langs scherpe randen, hitte en bewegende onderdelen.

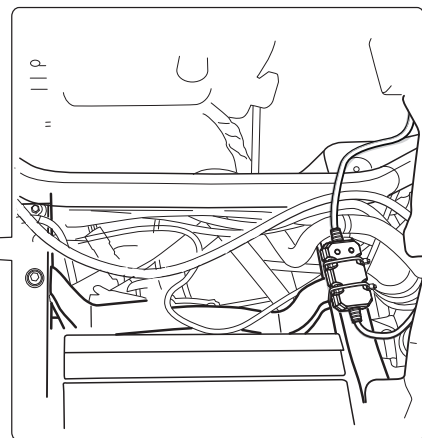

OPMERKING: Maak de kabels met de kabelbinders, op gelijke afstand van elkaar, goed vast aan het voertuig.



SNELSTARTGIDS

AXON WARN® HUB-ONTVANGER

AAN DRAAD RIJGEN

5.

- Koppel de kabelboom van het voertuigaccessoire los van de bedieningsschakelaar van de lier.
- Sluit één HUB-ontvangerconnector aan op de bedieningsschakelaar van de lier.
- Sluit de andere HUB-ontvangerconnector aan op de kabelboom van het accessoire.

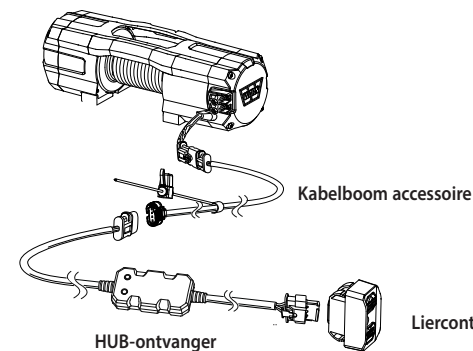

OPMERKING: Afbeelding toont de HUB-ontvangerverbinding bij de schakelaar. De HUB-ontvanger is ook aan te passen voor lierverbinding indien gewenst.

MOGENDHEID

6.

Schakel het voertuigvermogen in. **OPMERKING:** De HUB-ontvanger is actief wanneer het gele lampje brandt.

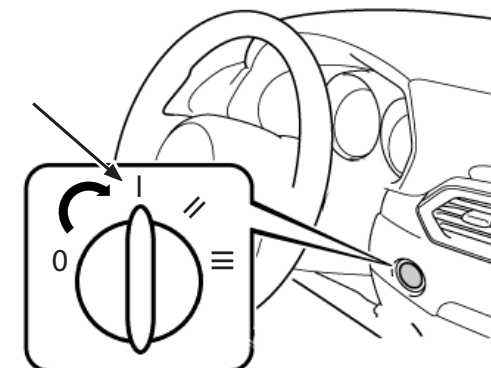
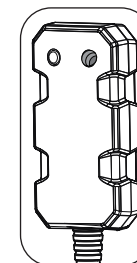

PAAR-/AANSLUITEN

7.

Houd de knop op de HUB-ontvanger ingedrukt totdat het blauwe lampje knippert (ongeveer 2 seconden), laat dan los.

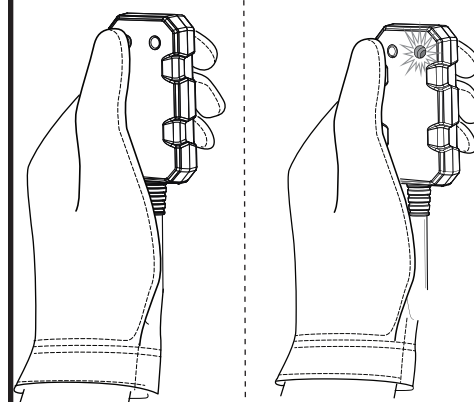

8.

Open de app op de telefoon en volg de aanwijzingen.



9.

Wanneer het lampje op de HUB-ontvanger groen gaat branden, is er verbinding.

Volg de aanwijzingen op de app.

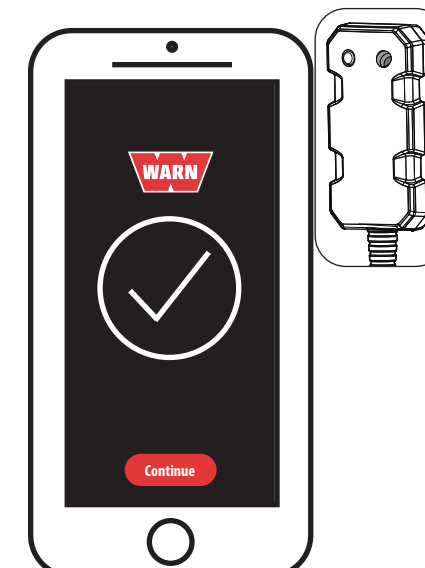

KLANTENSERVICE

WARN INDUSTRIES, INC. 12900 S.E. Capps Road,
Clackamas, OR 97015-8903, 1-503-722-1200
Klantenservice: 1-800-543-9276
Dealerservice: 1-800-910-1122
www.warn.com