

## Anbauanleitung Seilwindenanbausatz Land Rover Discovery 3 und 4

Best.-Nr.: 16 - 4950

AL: 1180 – 02



Hier sehen sie den fertig montierten Seilwindenanbausatz am Discovery 3.

Bevor sie mit der Montage beginnen lesen sie bitte diese Anleitung

und das Benutzerhandbuch



der Seilwinde gut durch.

### **Achtung:**

Bei Fahrten im öffentlichen Straßenverkehr muß das Rollenseilfenster mit einer Kunststoffabdeckung abgedeckt werden.

**Stückliste**  
**Seilwindenanbausatz Land Rover Discovery 3**  
**Best.nr.: 16 - 4950**

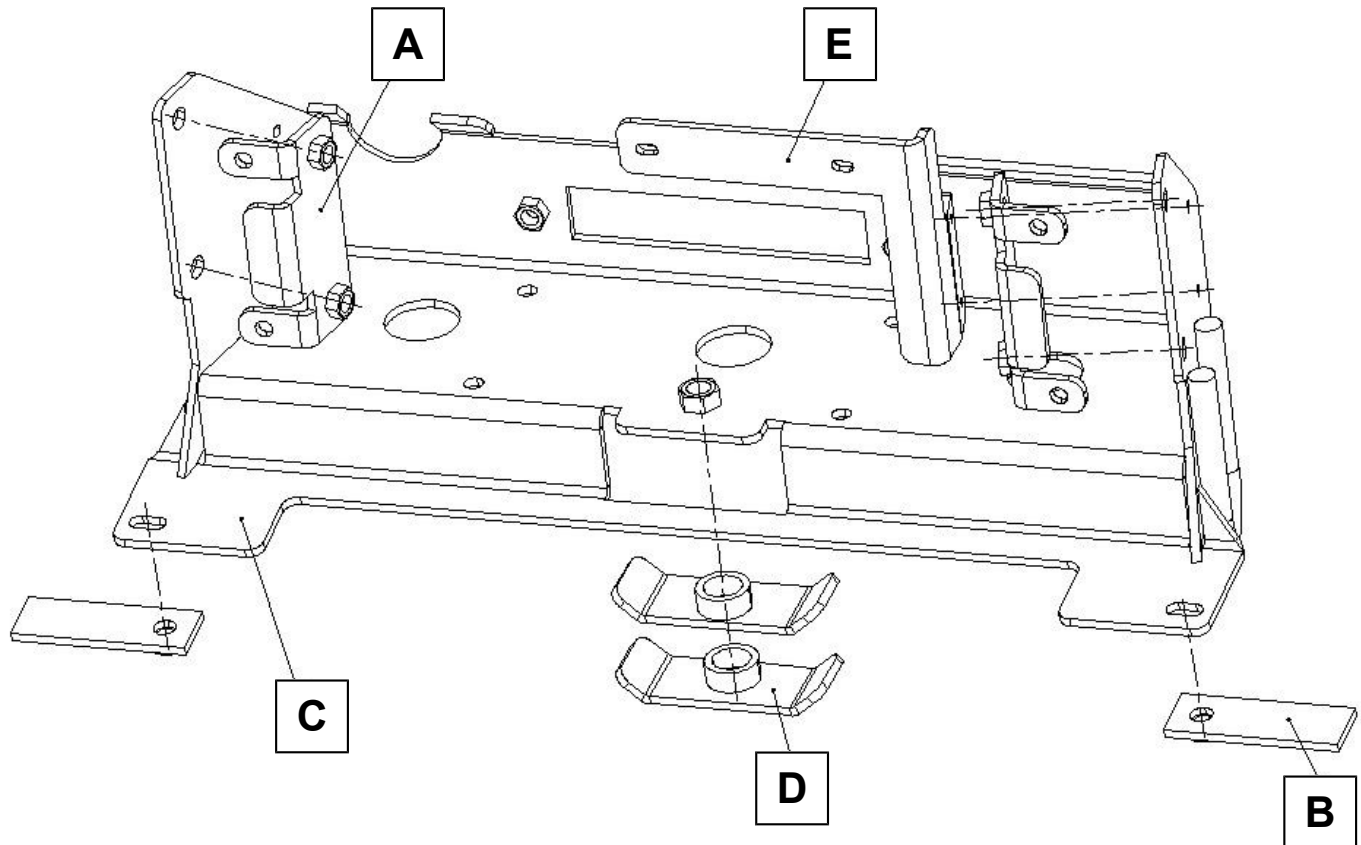

2 x Seitenhalter links ( A )	1 x Schraube M 16 x 70
2 x Gewindeplatte ( B )	1 x U- Scheibe M 16
1 x Seilwindenakssette ( C )	1 x Federring M 16
2 x Distanzplatte( D )	2 x Schraube M 12 x 40
1 x Schaltkastenhalter ( E )	4 x Schraube M 12 x 30
1 x Gutachten	6 x U - Scheibe M 12
1 x Anbauanleitung AL 1180	6 x Federring M 12
	2 x Schraube M 10 x 25
	2 x U – Scheibe M 10
	2 x Federring M 10
	4 x Schraube M 6 x 20
	6 x U – Scheibe M 6
	4 x Federring M 6
	2 x Mutter M 6





1



2



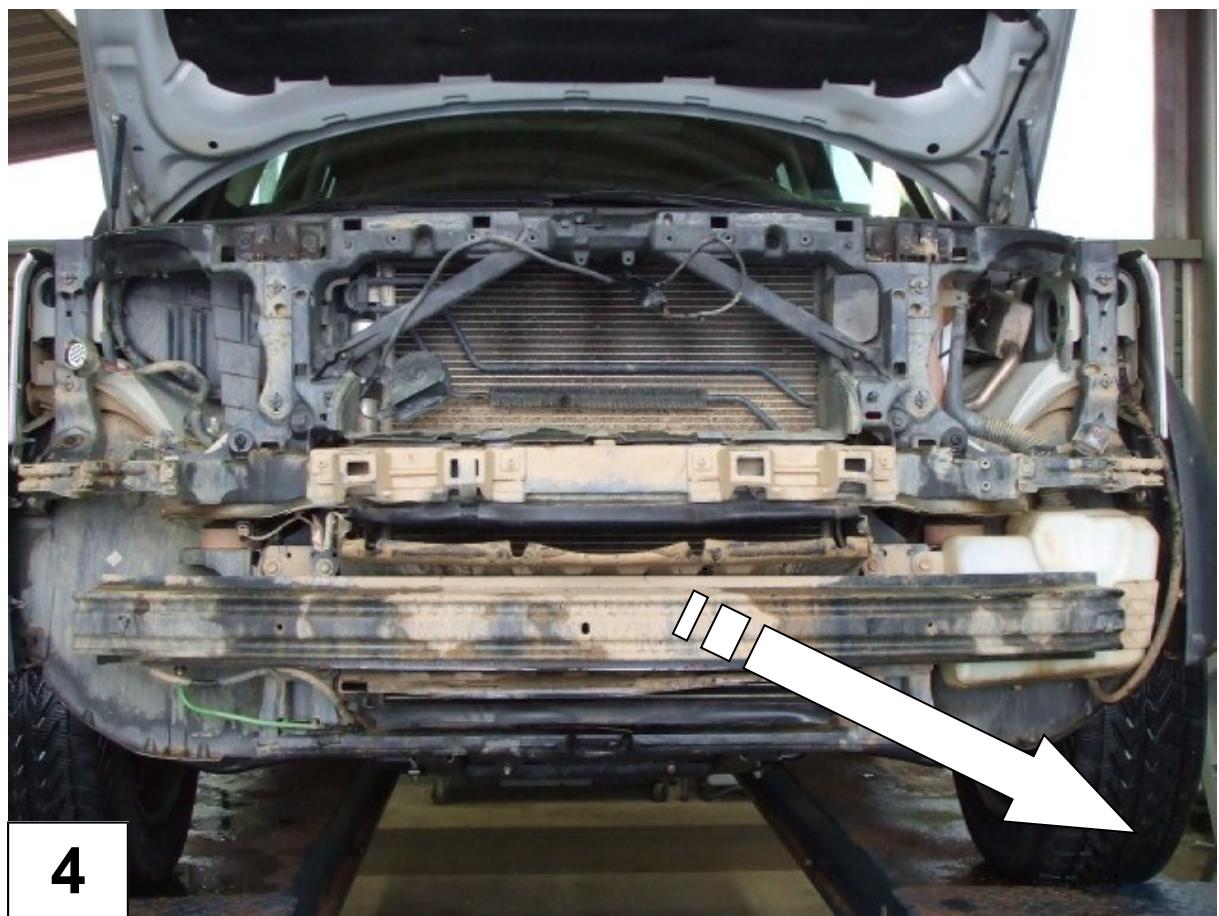
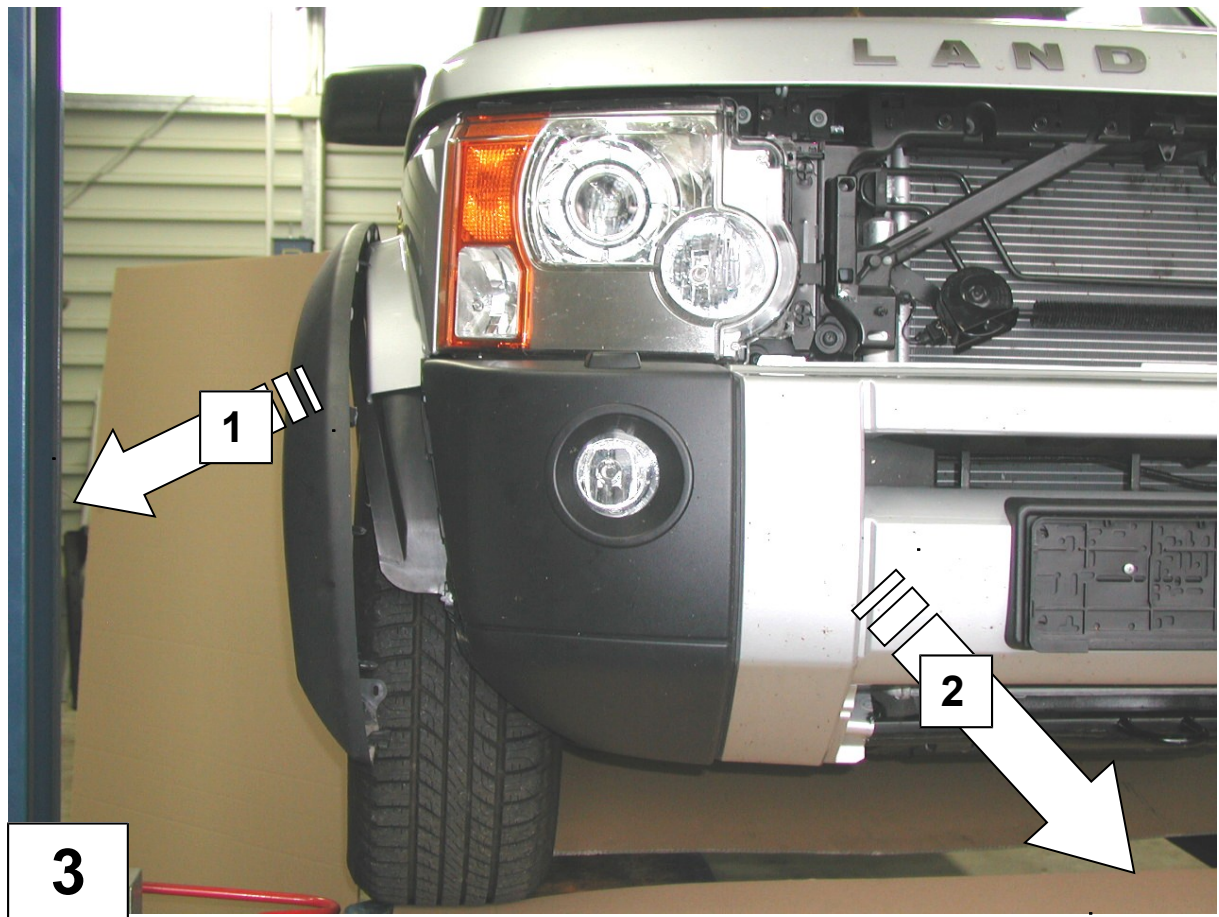



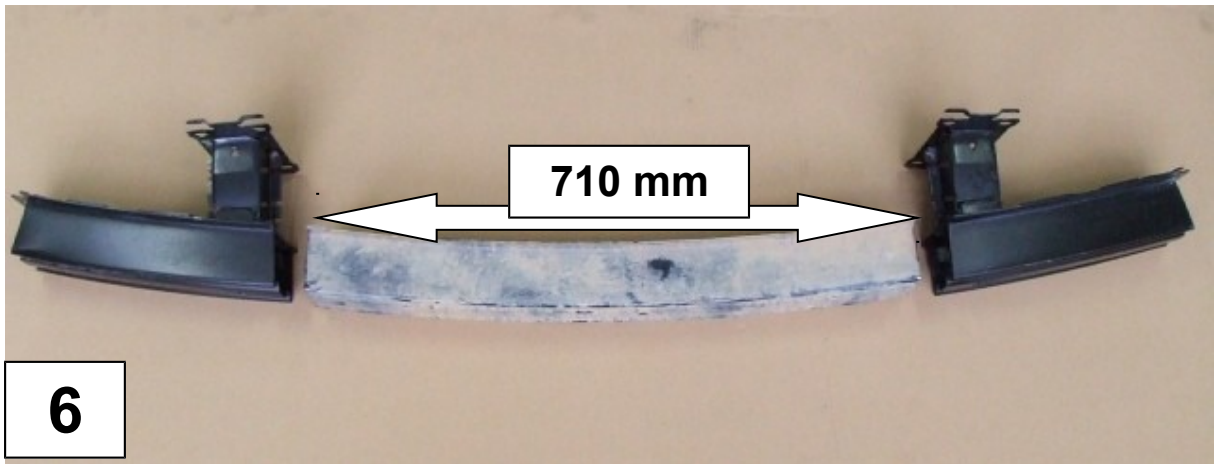
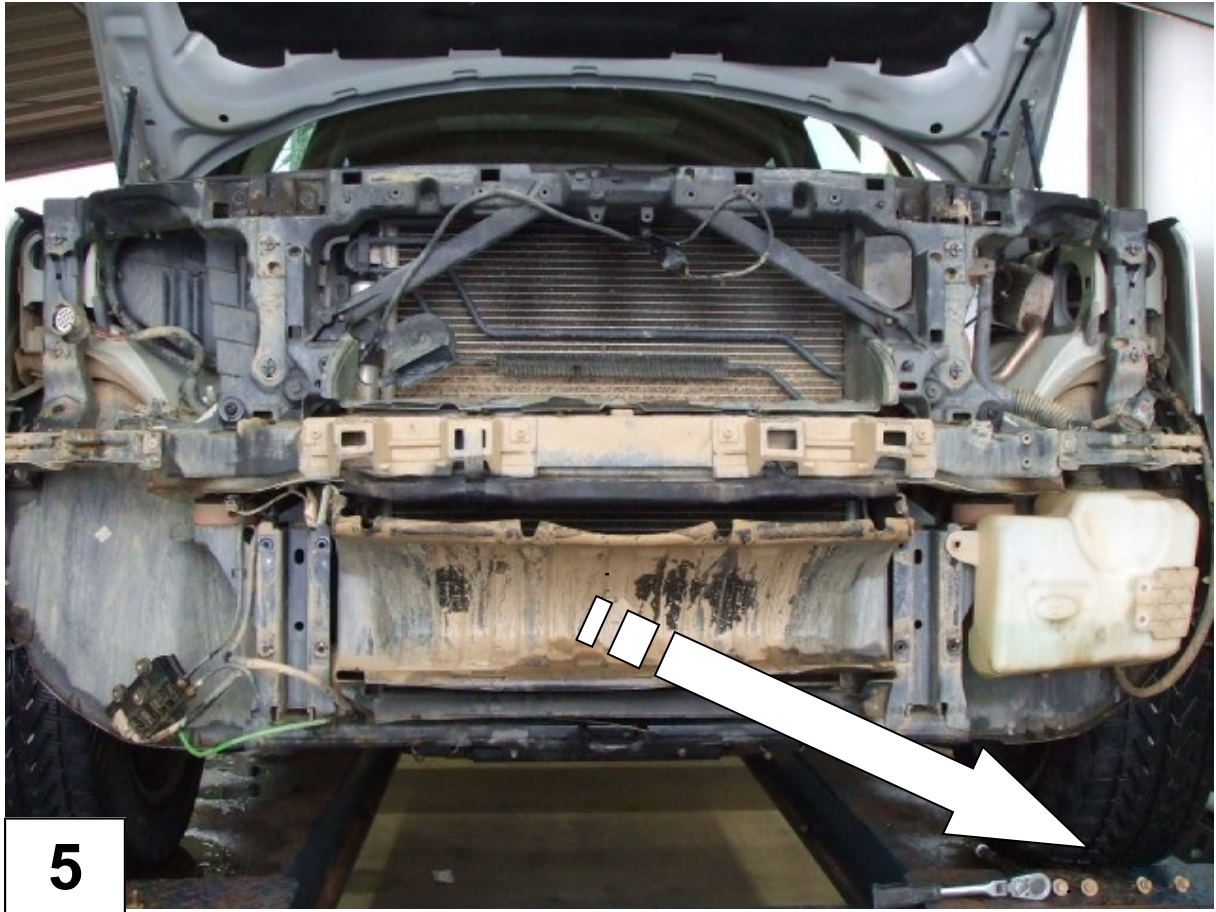



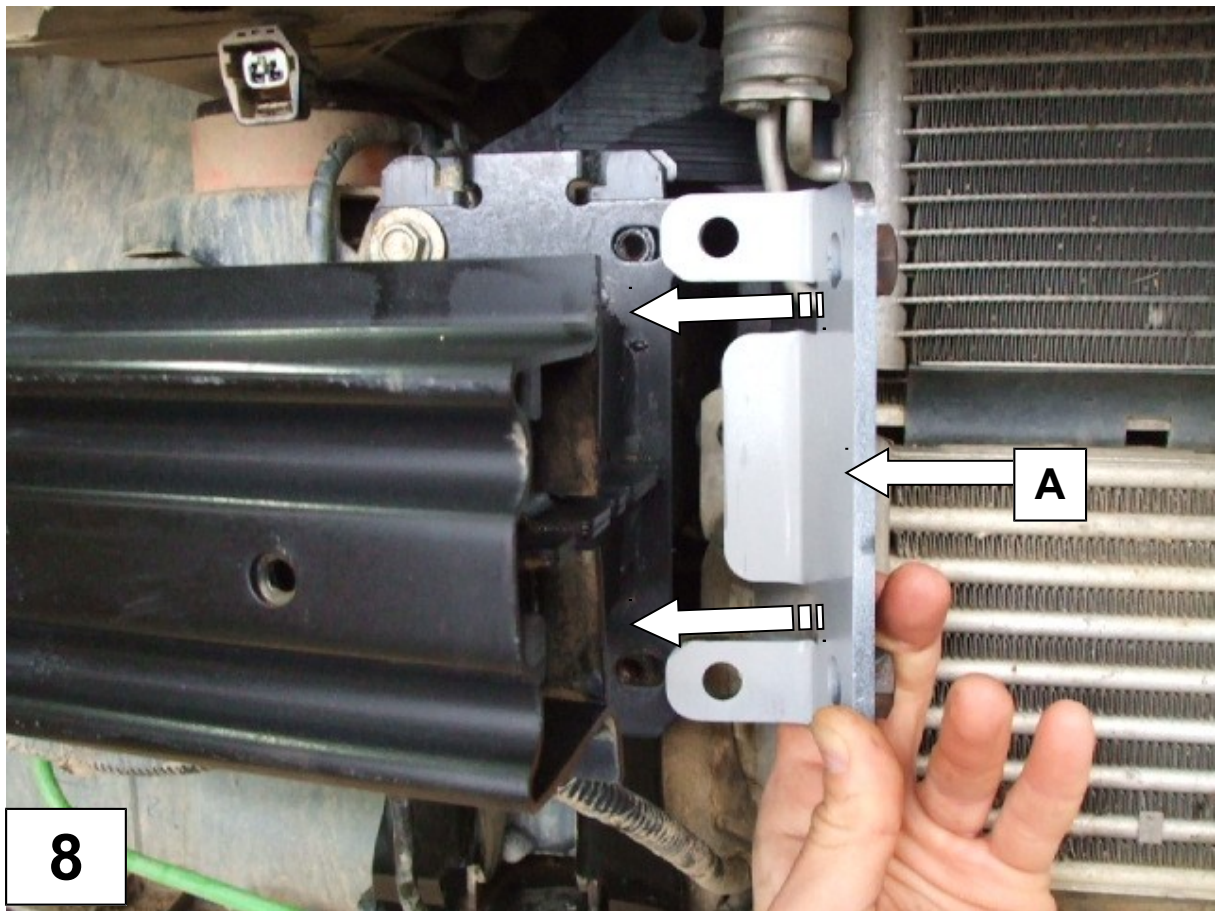
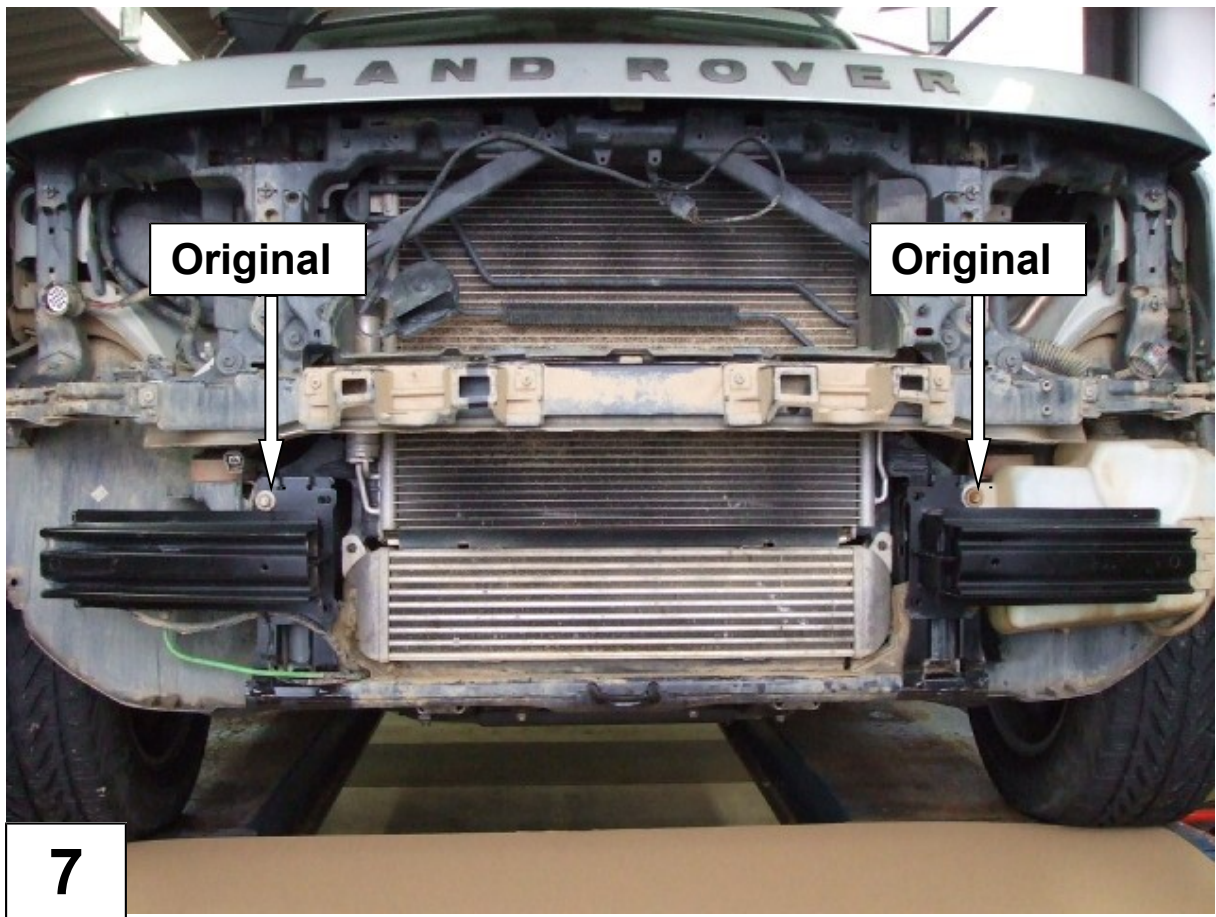



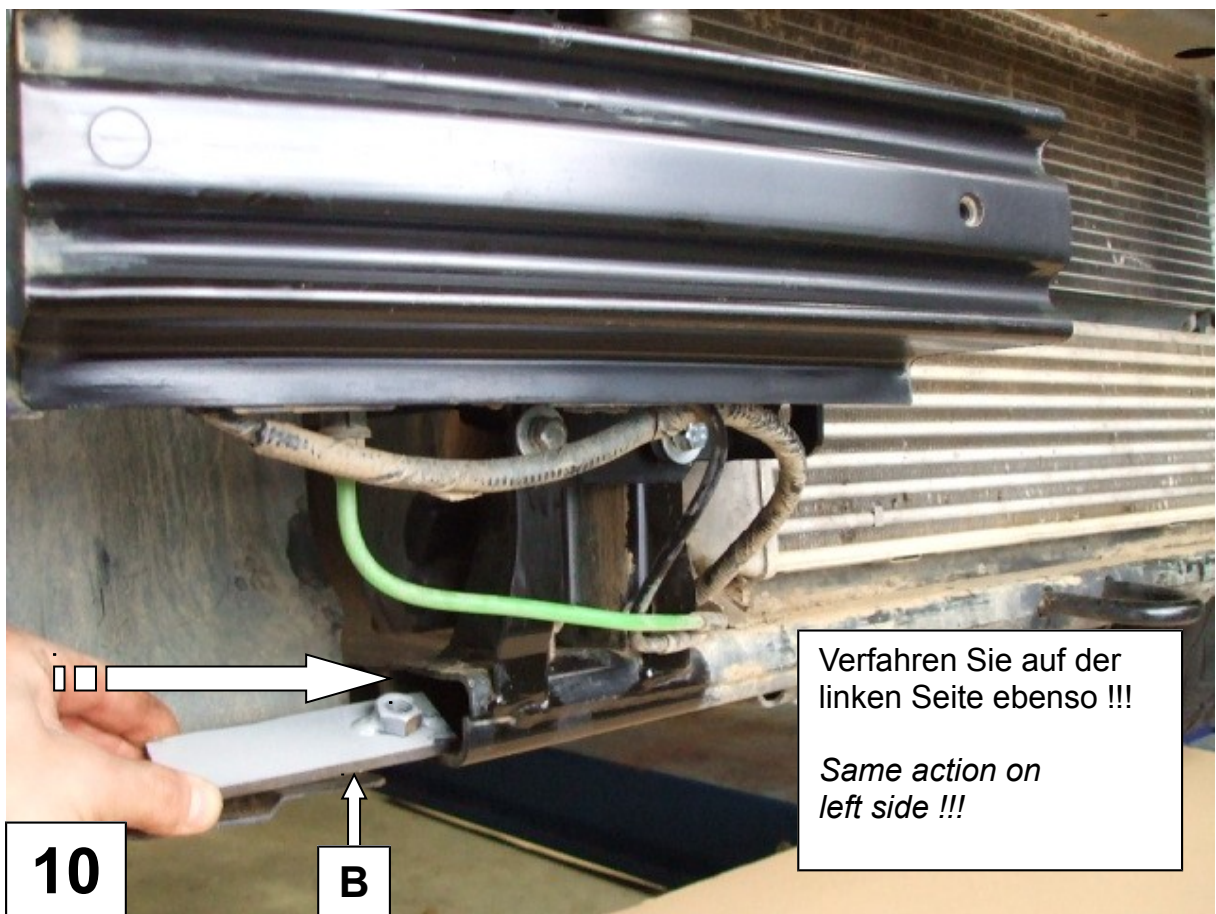
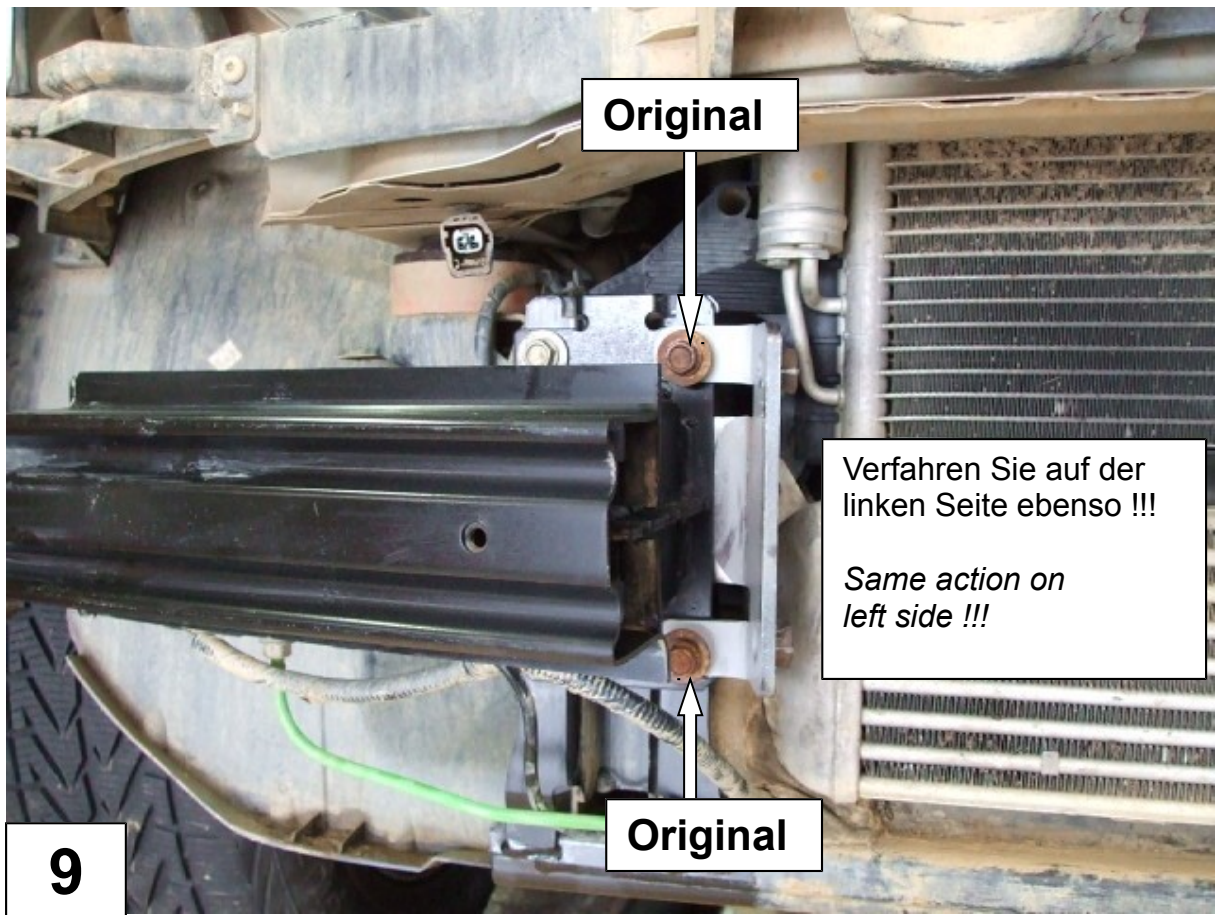



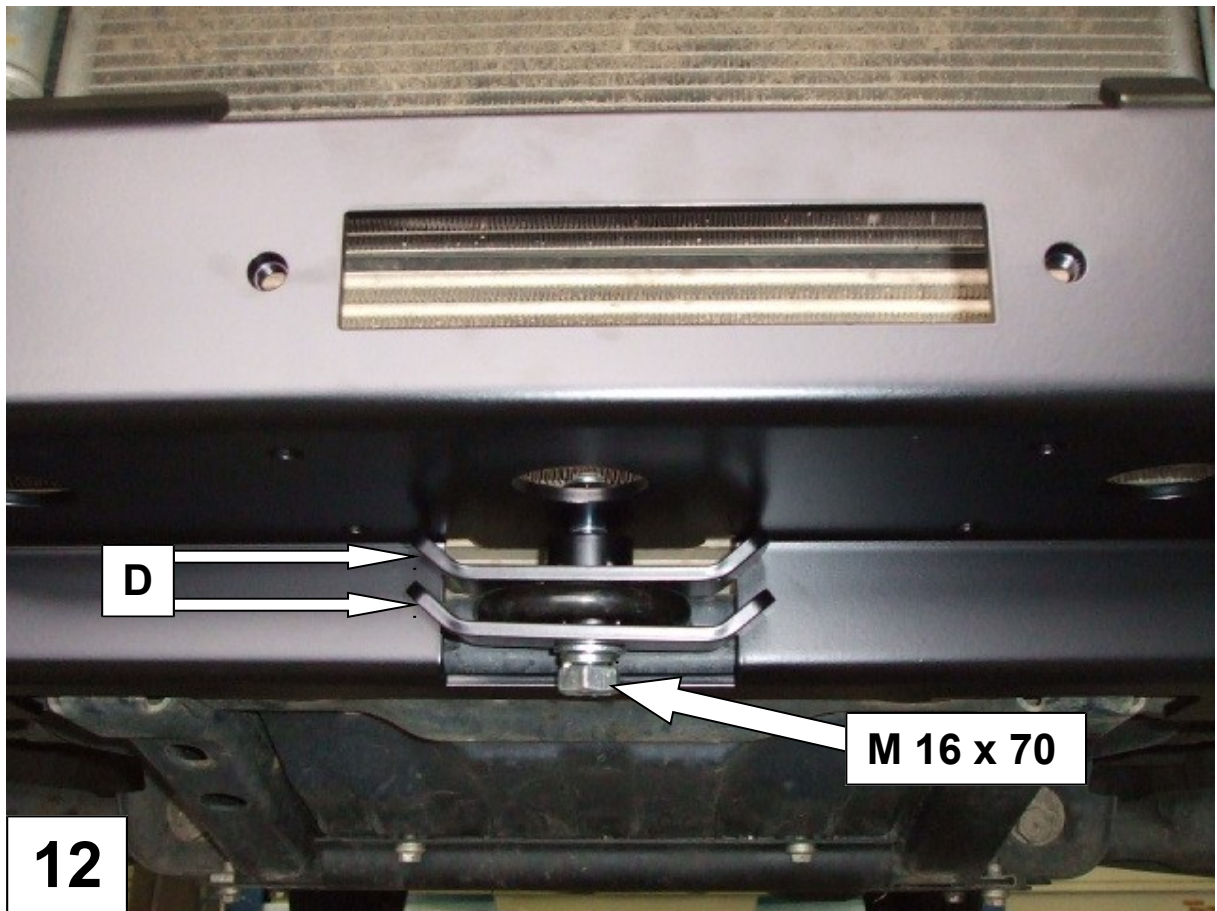
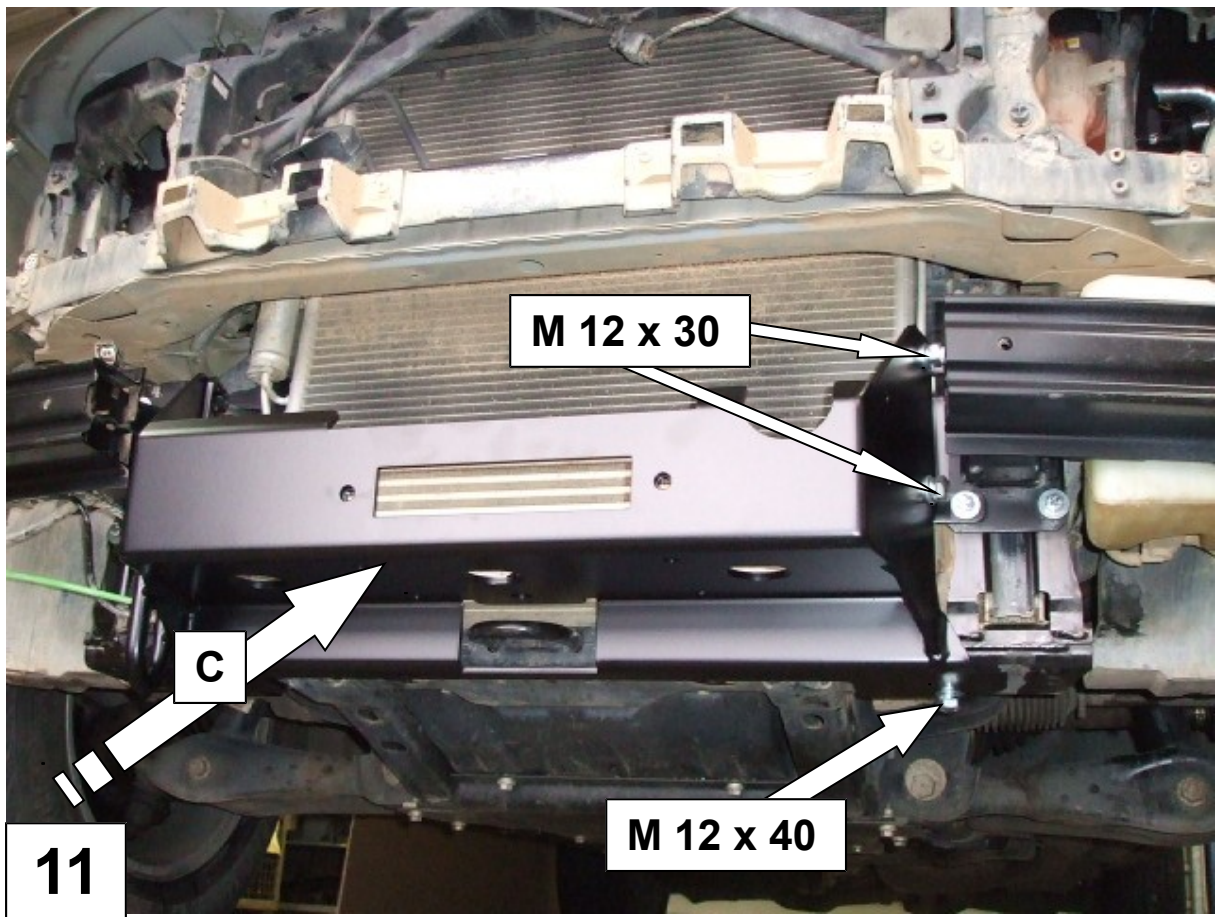



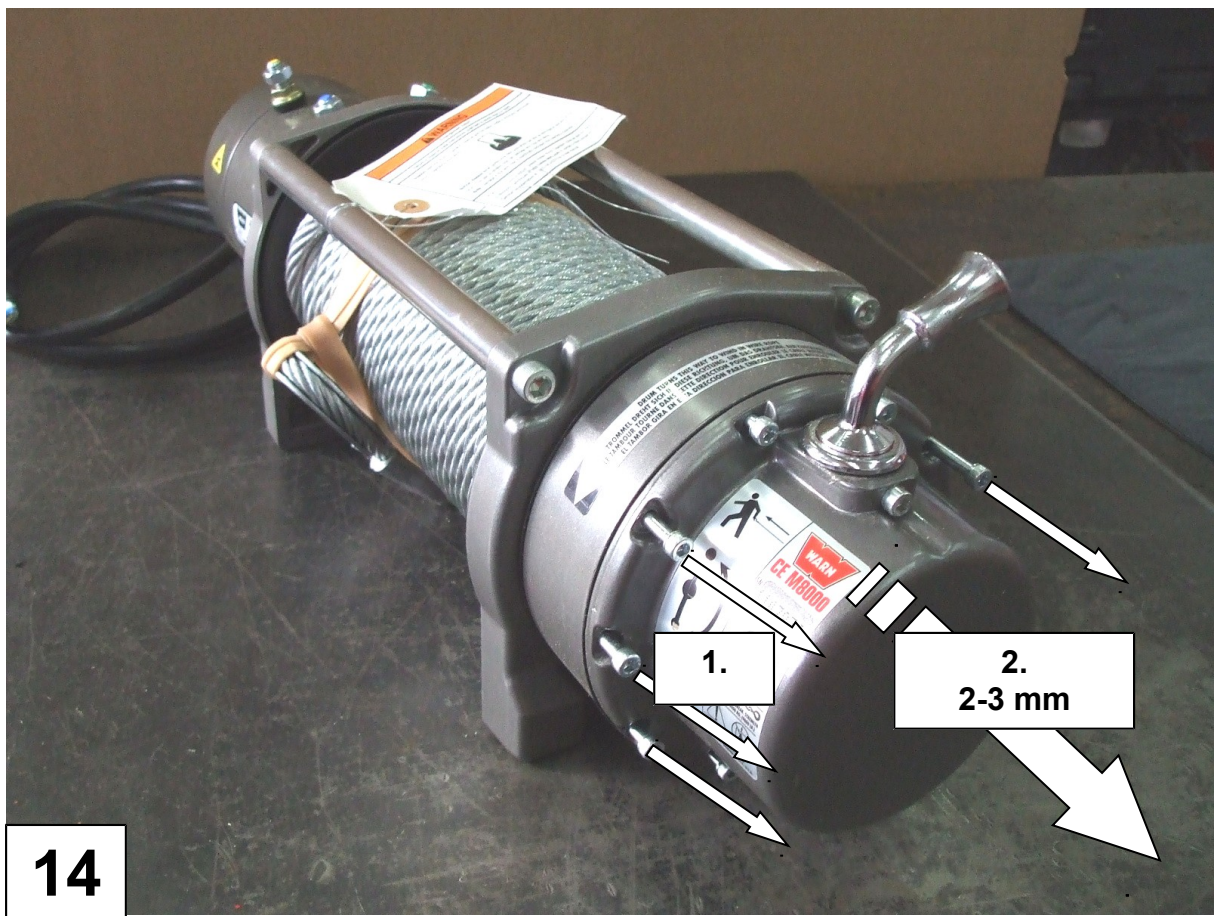



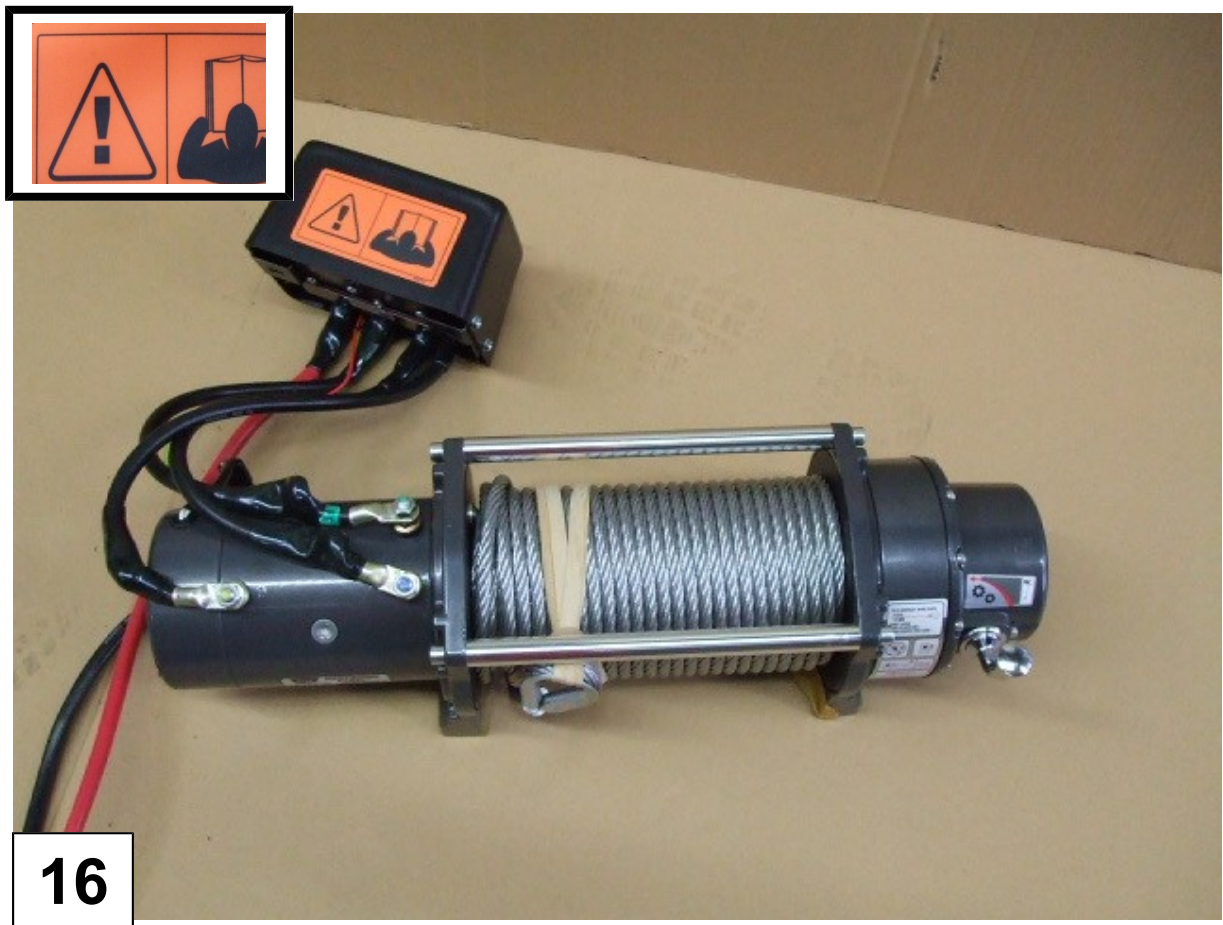
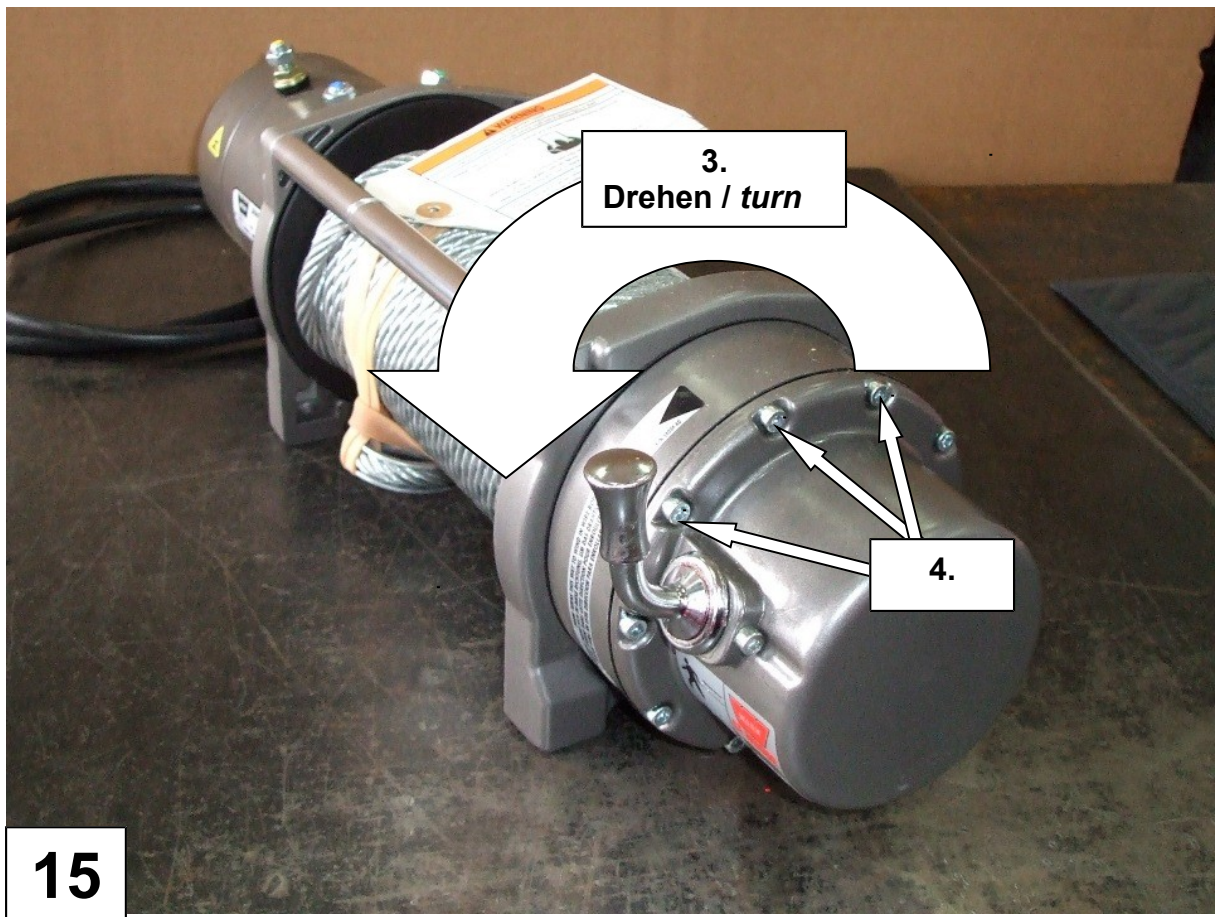



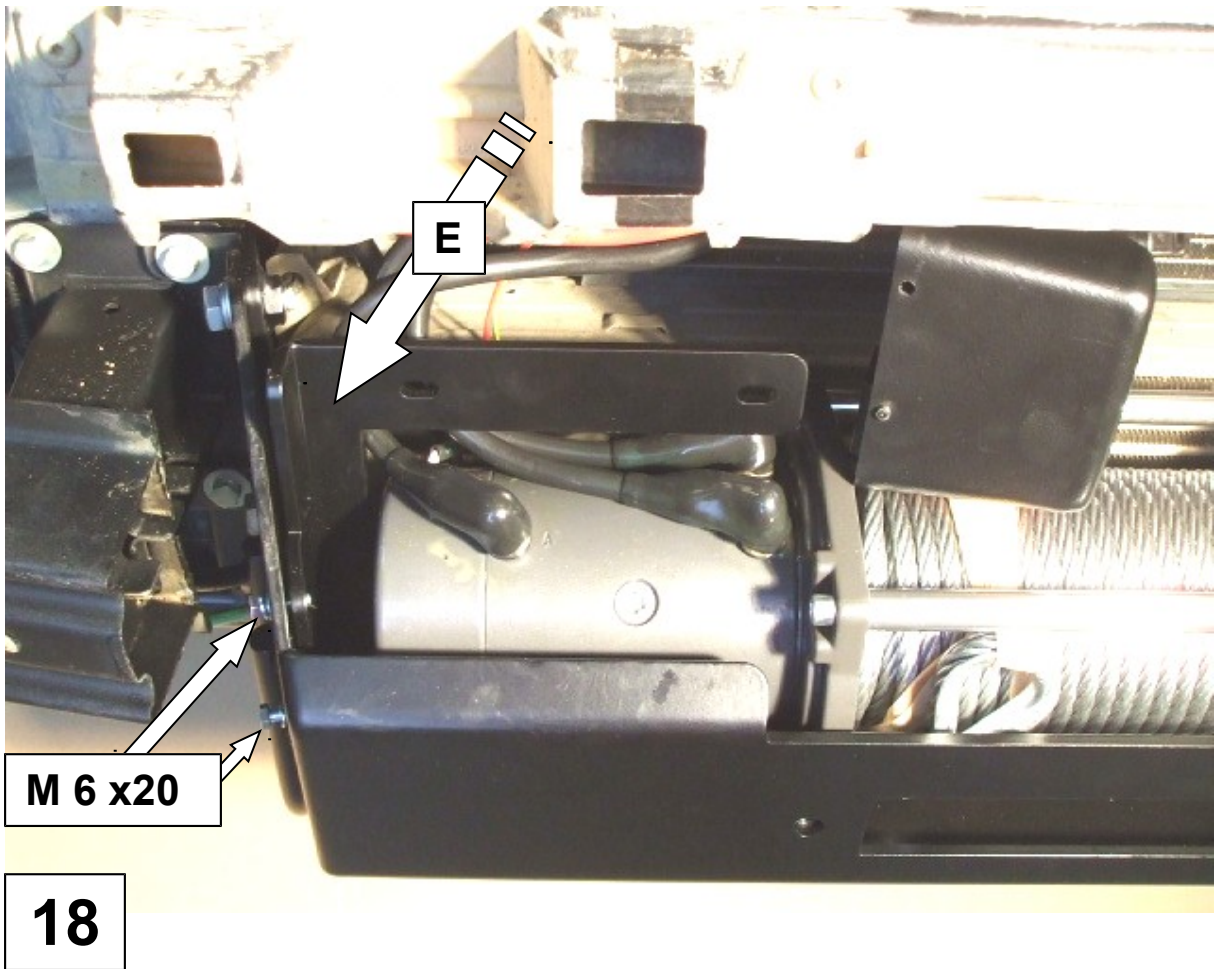
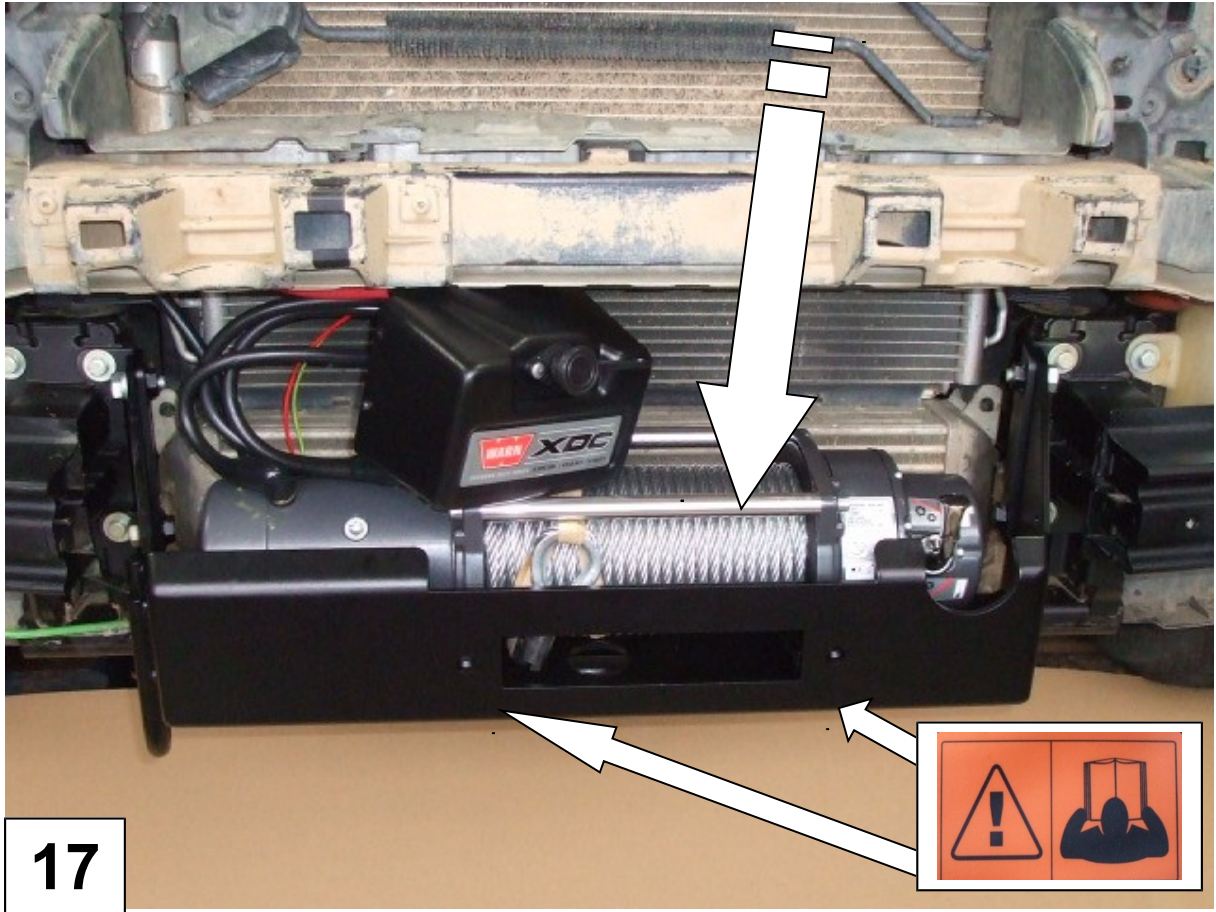



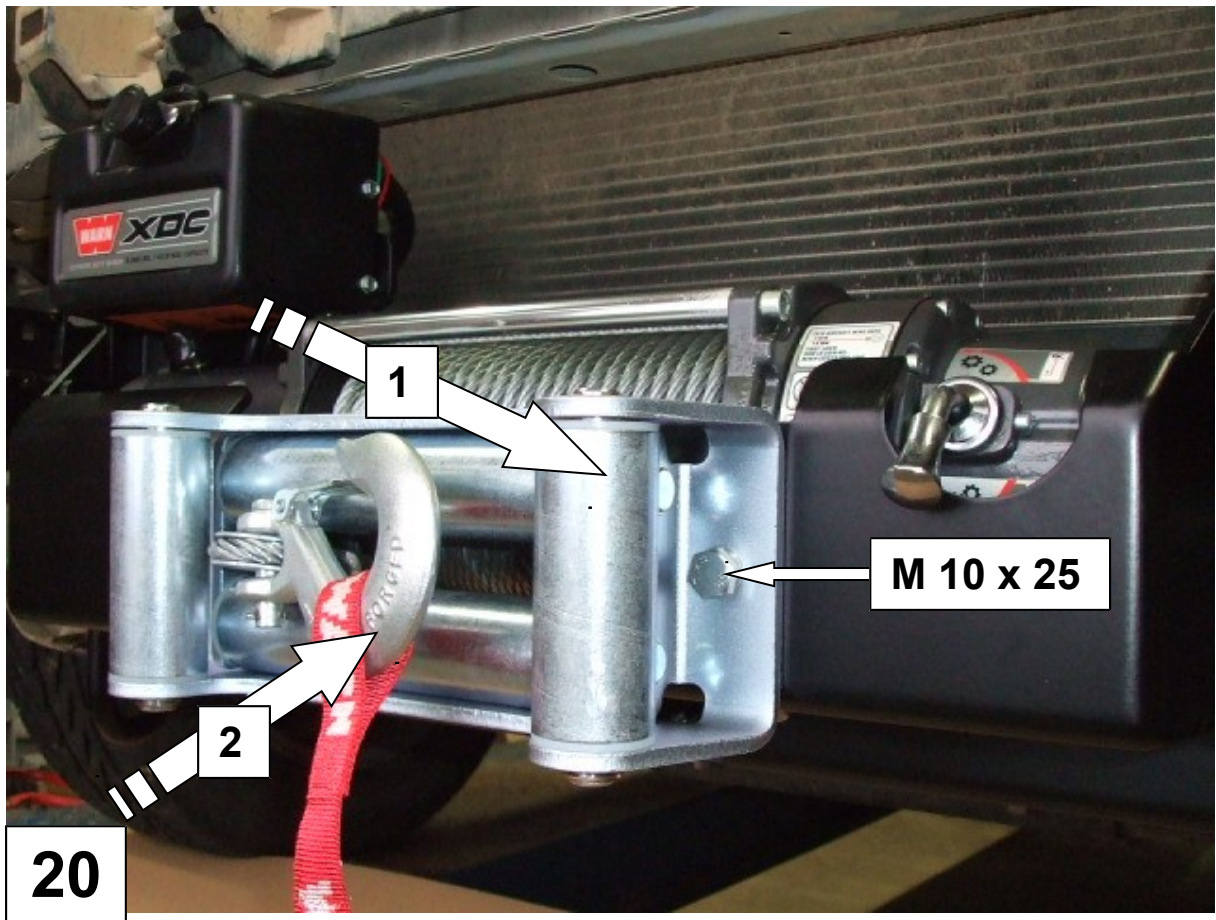
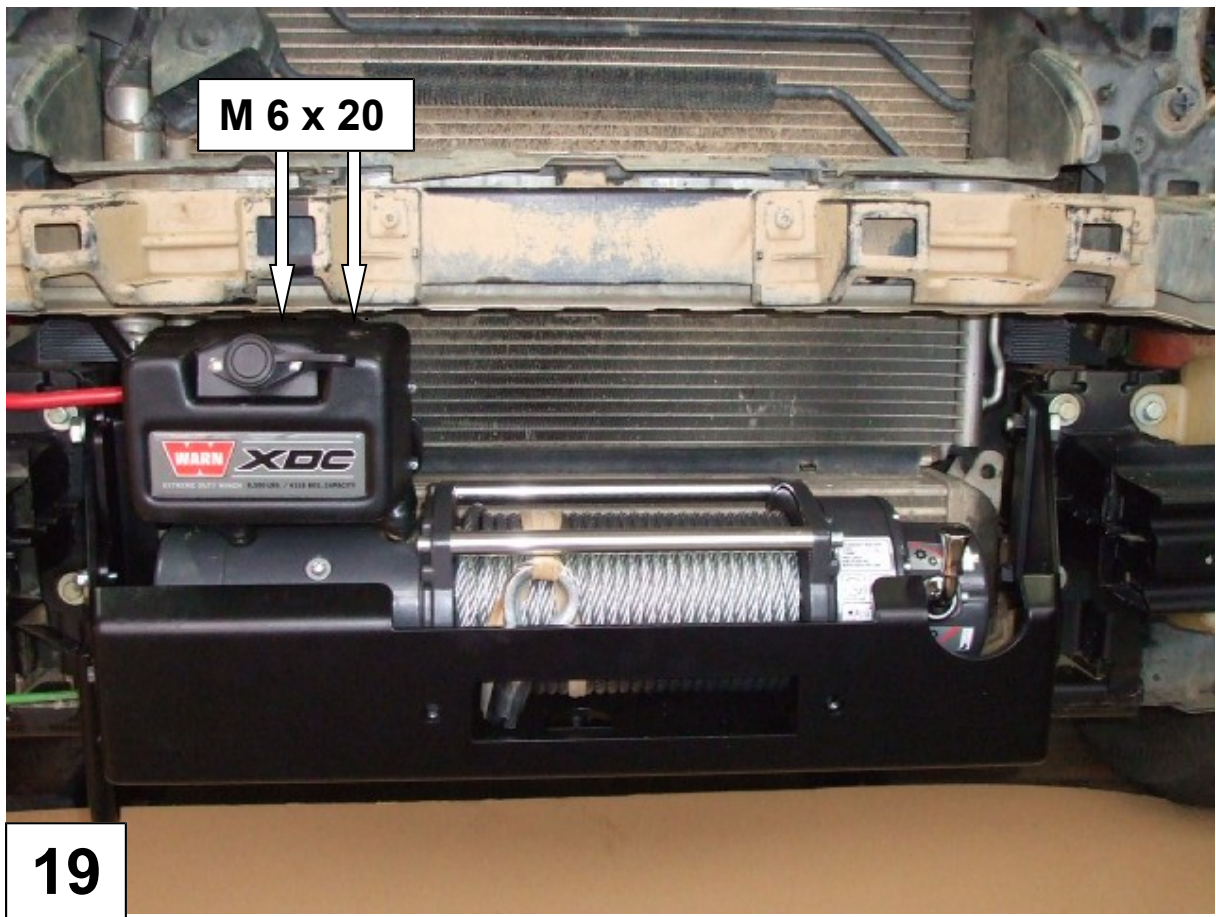



Discovery 3



21

Discovery 3



22

Discovery 3

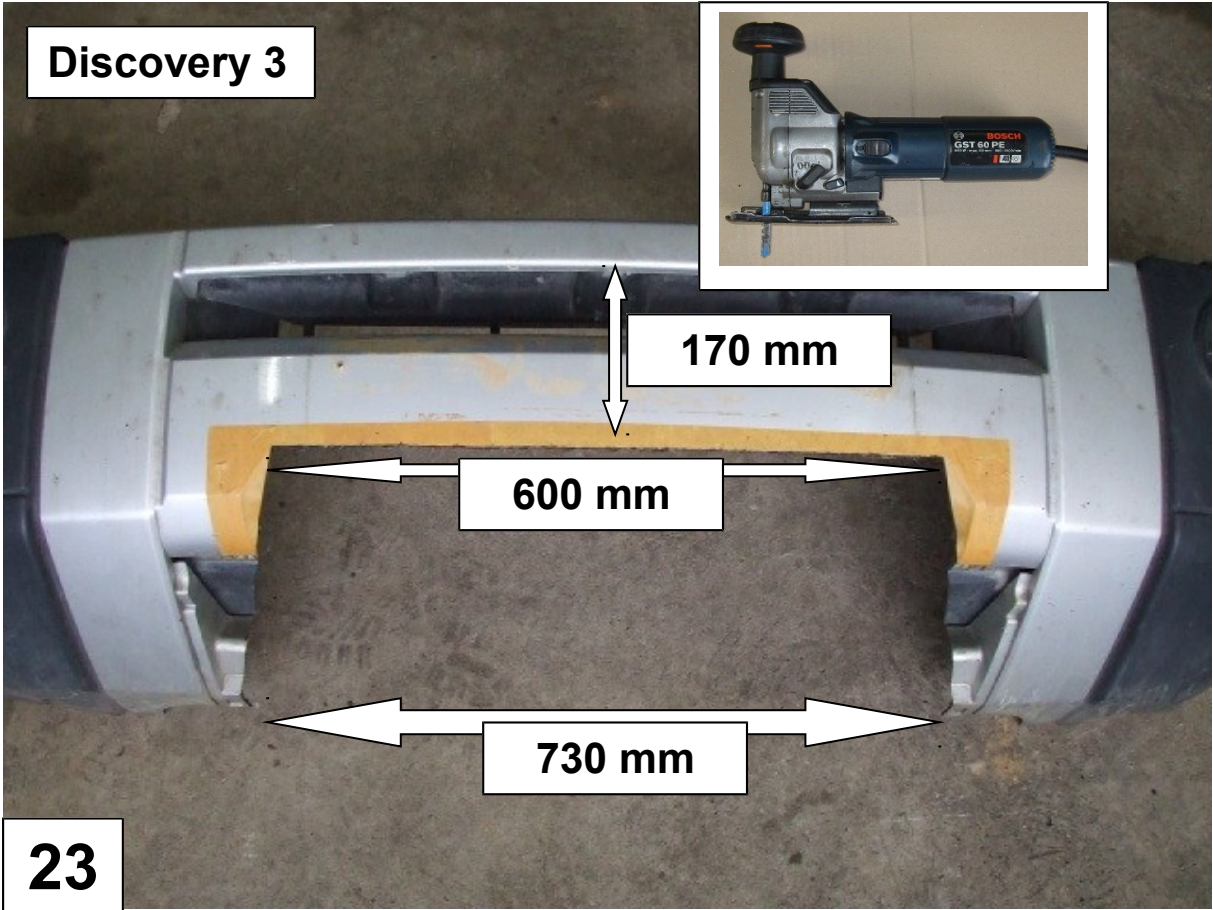

23

Discovery 4

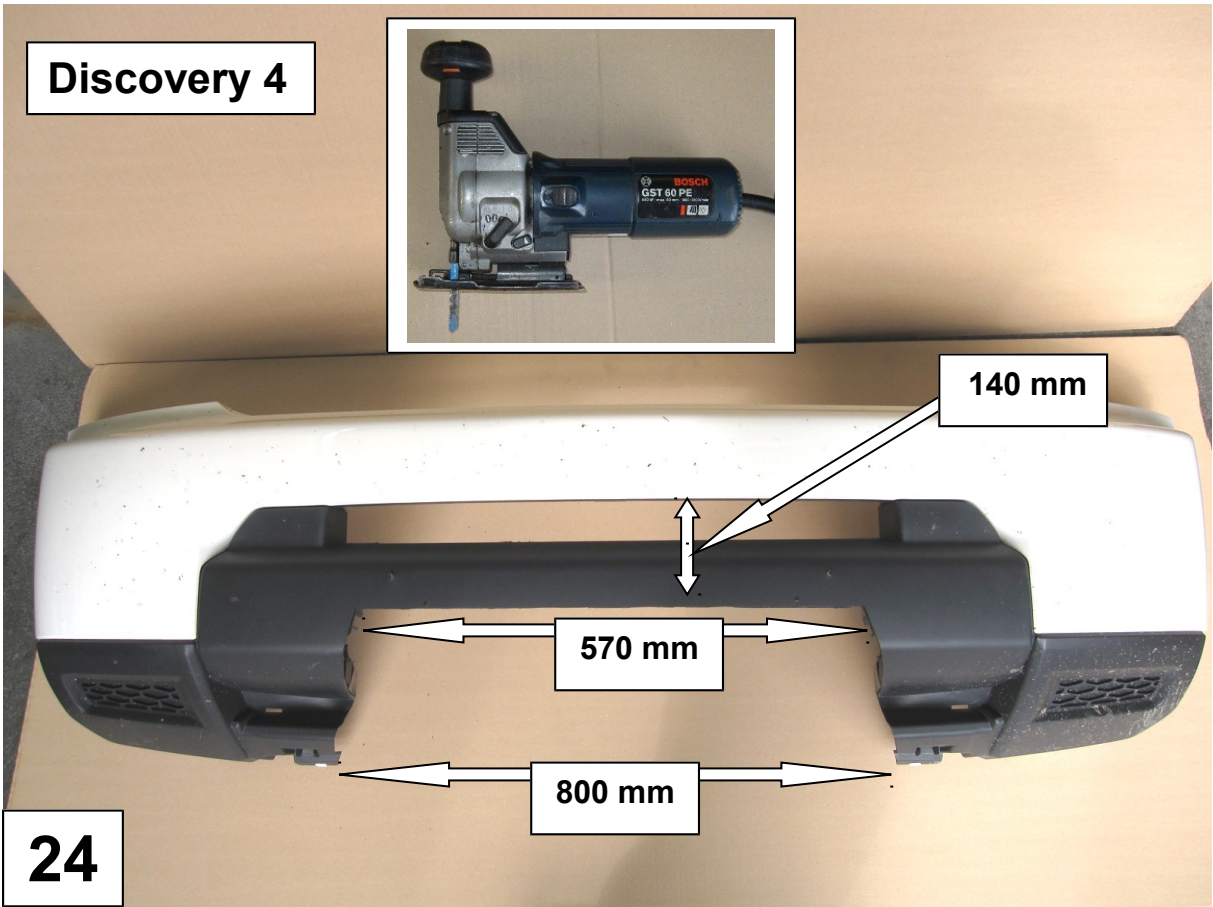

24



**Discovery 4**

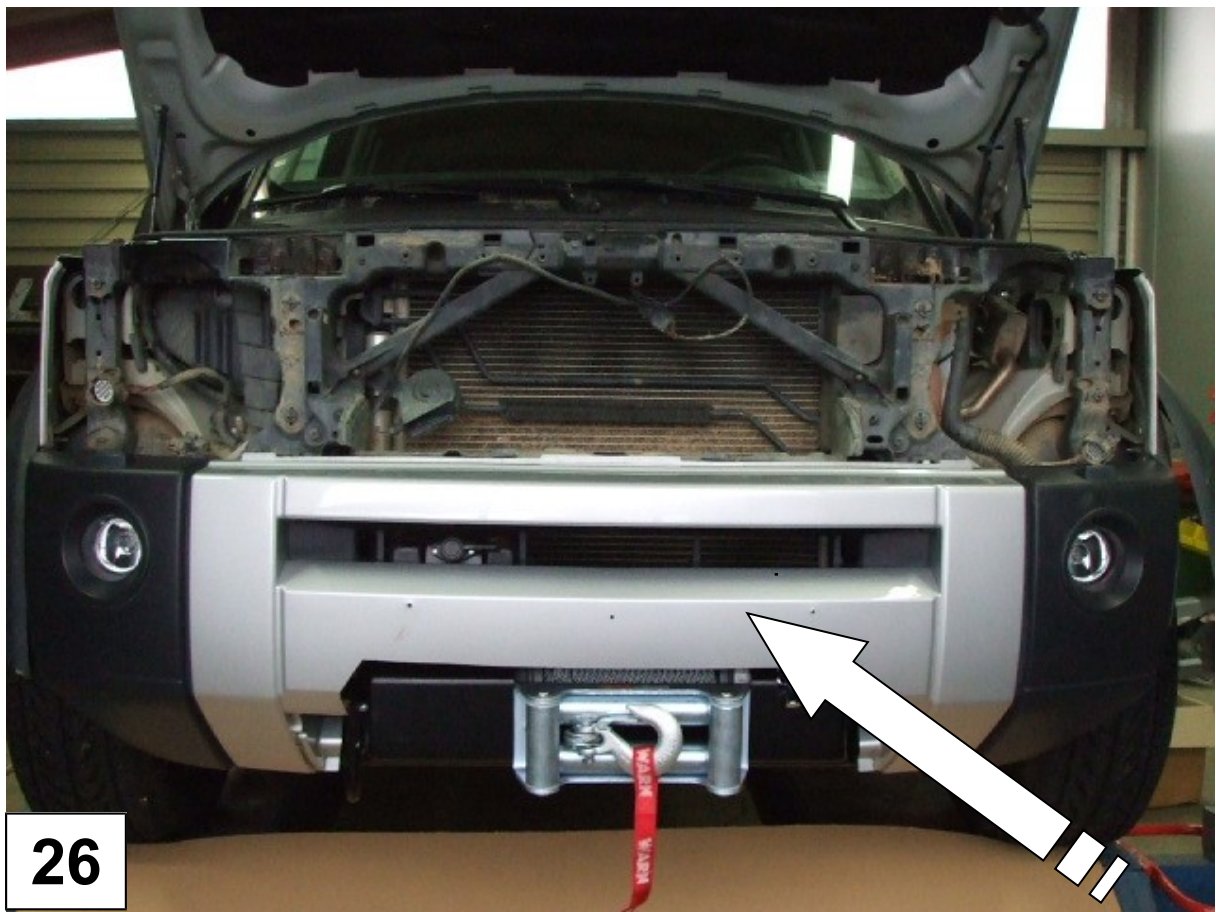
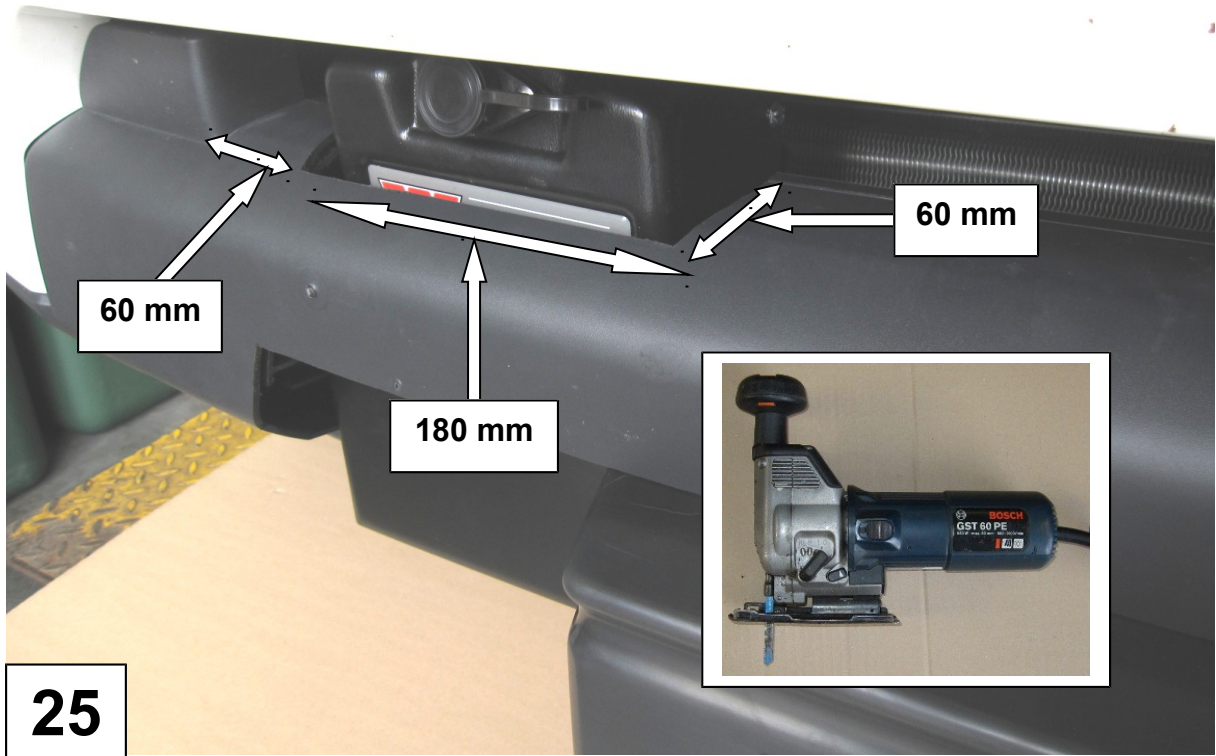



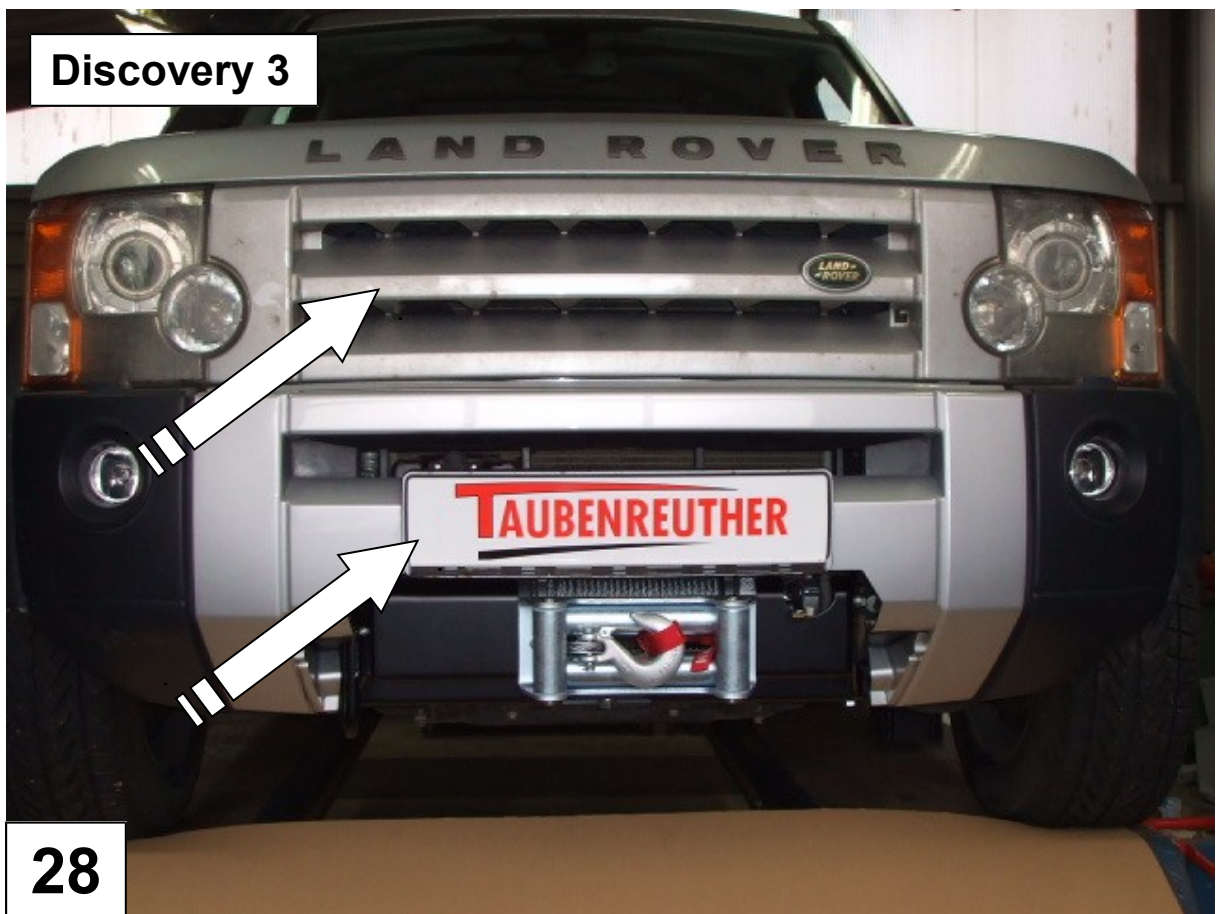
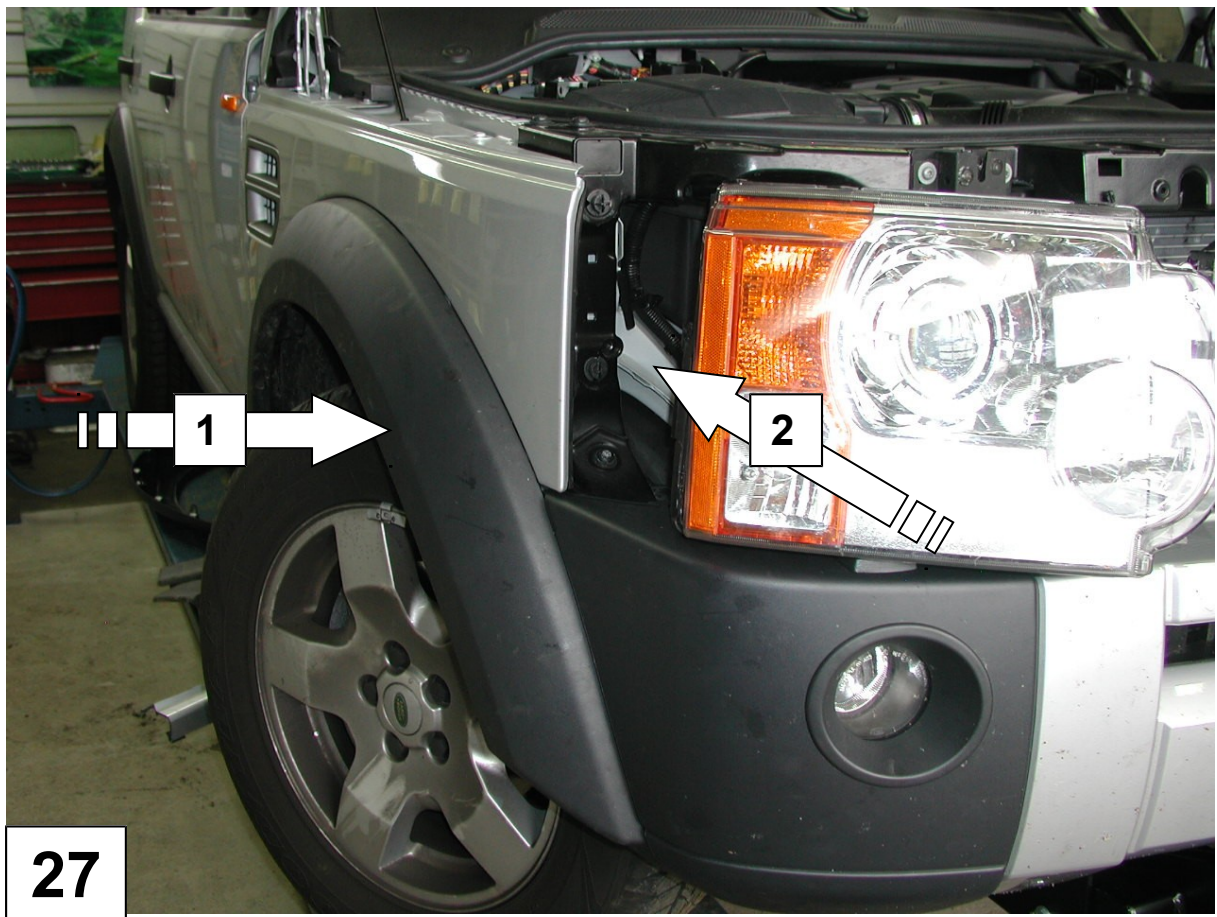



Discovery 4



29