



FITTING INSTRUCTIONS

PART NUMBER AND DESCRIPTION:

3640130 – REAR STEP TOW BAR (RSTB) WITHOUT FACTORY PARK SENSORS

3640140 – REAR STEP TOW BAR (RSTB) WITH FACTORY PARK SENSORS

SUITED TO VEHICLE/S:

FORD RANGER 2011 ON

WARNING

NOTE THE FOLLOWING:

- ◆ This product must be installed exactly as per these instructions using only the hardware supplied.
- ◆ In the event of damage to any tow bar component, contact your nearest authorised ARB stockist.
- ◆ Do not use this product for any vehicle make or model, other than those specified by ARB.
- ◆ Do not remove labels from this tow bar.
- ◆ This product or its fixing must not be modified in any way.
- ◆ The installation of this product may require the use of specialized tools and/or techniques
- ◆ It is recommended that this product is only installed by trained personnel.
- ◆ These instructions are correct as at the publication date. ARB Corporation Ltd. cannot be held responsible for the impact of any changes subsequently made by the vehicle manufacturer.
- ◆ During installation, it is the duty of the installer to check correct operation/clearances of all components.
- ◆ Work safely at all times.
- ◆ Unless otherwise instructed, tighten fasteners to specified torque.
- ◆ The eyelets on the rear bar have been designed and tested for connection of trailer safety chains. They are not to be used for recovery or direct towing.
- ◆ For recovery, fit a suitable and rated tow hitch to the central tow hitch receiver.
- ◆ Position high lift jack at lift locations beneath the middle of the wings and corner of the RSTB. Do not lift directly from the end of the wing.
- ◆ When using the tow hitch receiver, the centre panel should be in the raised position.

ARB 4x4 ACCESSORIES

Corporate Head Office

42-44 Garden St
Kilsyth, Victoria
AUSTRALIA 3137

Tel: +61 (3) 9761 6622
Fax: +61 (3) 9761 6807

Australian enquiries
North & South American enquiries
Other international enquiries

sales@arb.com.au
sales@arbusa.com
exports@arb.com.au

www.arb.com.au

GENERAL CARE AND MAINTENANCE

By choosing an ARB Bar, you have bought a product that is one of the most sought after 4WD products in the world. Your bar is a properly engineered, reliable, quality accessory that represents excellent value. To keep your bar in original condition it is important to care and maintain it following these recommendations:



- Prior to exposure to the weather your bar should be treated to a Canuba based polish on all exposed surfaces. It is recommended that this is performed on a six monthly basis or following exposure to salt, mud, sand or other contaminants.
- As part of any Pre Trip Preparation, or on an annual basis, it is recommended that a thorough visual inspection of the bar is carried out, making sure that all bolts and other components are torqued to the correct specification. Also check that all wiring sheaths, connectors, and fittings are free of damage. Replace any components as necessary. This service can be performed by your local authorized ARB Stockist.

FITTING REQUIREMENTS

REQUIRED TOOLS FOR FITMENT OF PRODUCT:

BASIC TOOL KIT	SIDE CUTTERS
INSULATION TAPE	70MM HOLE SAW BIT
DEUTSCH CRIMPING TOOL	WIRE STRIPPER
NEEDLE NOSE PLIERS	POWER DRILL
ALLEN KEY SET	SOCKET SET
FINE ROUND FILE	TAPE MEASURE
MASKING TAPE	RUST PREVENTATIVE PAINT
HEAT SHRINK + HEAT GUN	SOLDERING IRON + SOLDER
MULTIMETER	

HAVE AVAILABLE THESE SAFETY ITEMS WHEN FITTING PRODUCT:

Protective eyewear		Hearing protection	
--------------------	---	--------------------	---

NOTE: 'WARNING' notes in the fitting procedure relate to OHS situations, where to avoid a potentially hazardous situation it is suggested that protective safety gear be worn or a safe work procedure be employed. If these notes and warnings are not heeded, injury may result.

FASTENER TORQUE SETTINGS:

SIZE	Torque Nm	Torque lbft
M6	9 Nm	7 lbft
M8	22 Nm	16 lbft
M10	44 Nm	32 lbft
M12x1.75	77 Nm	57 lbft
M12x1.25	95 Nm	71 lbft

RSTB PARTS LISTING

APPLICATION	PART NO.	QTY	DESCRIPTION
PREPARE REAR STEP TOW BAR (RSTB)	6522998	2	STONE GUARD PANEL
	6151300	4	NUT CAGED M6 2.6-3.5
	6151560	2	BOLT HXHD M6 x 1.0 x 16 GR8.8 BTZP480
	6151550	2	BOLT HXHD M6 x 1.0 x 25 GR8.8 BTZP480
	4581287	4	WASHER SPRING M6 x 2.5 x 1.6 BLK ZN
	4584295	8	WASHER FLAT M6 x 12 x 1.3 BLK ZN
	6523002	1	LIFT UP PANEL
	5670026	2	SPRING EXT 11.25 OD x 43
	6151256	2	SCREW BTN HD M6 x 16 SS
	6602011	2	CANOE CLIP
6151549	2	NUT NYLOC M6 x 1.0 GR8.8 BTZP480	
RSTB TO VEHICLE	3759002R	1	CHASSIS DOUBLE NUT PLATE RH
	3759002L	1	CHASSIS DOUBLE NUT PLATE LH
	3194397	2	CHASSIS SINGLE NUT PLATE
	6151255	4	BOLT M12 x 1.75 x 40 Gd 8.8 ZP
	4581049	10	WASHER FLAT 1/2 x 1.1/8 x 3MM ZP
	4581050	10	WASHER SPRING 1/2 x 3/16 x 3/16 ZP
	6151096	6	BOLT HXHD M12 x 1.25 x 40 CL8.8 ZP
LICENSE PLATE TO VEHICLE	3789541	1	TEMPLATE RSTB L/PLATE
	3194833	1	PLATE 10MM SPANNER
	3759696	1	BRKT NUMBER PLATE FRAME
	6151384	4	SCREW ST PHDCOL PH 5.2 x 16 TBZP480
	3759829R	1	BRKT NUMBER PLATE MOUNT RH
	3759829L	1	BRKT NUMBER PLATE MOUNT LH
	6821189	4	PLASTIC SNAP-IN LARGE GROMMET
	5848302	2	PACKER RB NYLON
	4581082	2	WASHER FLAT M6 x 19 x 1.6 BLK ZN
	6151549	6	NUT NYLOC M6 x 1.0 GR8.8 BTZP480
	6151213	8	BOLT M6 x 1.0 x 20 Gd8.8 BZ
	4581287	2	WASHER SPRING M6 x 2.5 x 1.6 BLK ZN
4584295	14	WASHER FLAT M6 x 12 x 1.3 BLK ZN	
STEP PLATE TO RSTB	3194725	1	STEP PLATE EXTRUSION
	3163125	1	LIGHT BEZEL MOULDING
	3759536	1	LED MOUNT BRKT
	6151256	8	SCREW BTN HD M6 x 16 SS
	6151715	16	NUT M6 CAGED 3.6-4.5MM 836-D
	6821270	1	NARVA 90810 KIT W/ GASKET & SCREWS
	6821116	2	PLASTIC SNAP-IN SMALL GROMMET
PREPARE RSTB/VEHICLE FOR PANELS	3759547R	1	WING MOUNT STRUT RH
	3759547L	1	WING MOUNT STRUT LH
	3759545R	1	WING MOUNT BRKT RH
	3759545L	1	WING MOUNT BRKT LH
	3194724	2	WING TRIPLE NUT PLATE
	3194723	2	WING DOUBLE NUT PLATE
	3789361	1	TEMPLATE RSTB RANGER WING
	6151255	2	BOLT M12 x 1.75 x 40 Gd 8.8 ZP
	4581049	2	WASHER FLAT 1/2 x 1.1/8 x 3MM ZP
	4581050	2	WASHER SPRING 1/2 x 3/16 x 3/16 ZP
	6151234	6	BOLT M8 x 1.25 x 25 Gd 8.8 BP
	4581063	6	WASHER FLAT M8 x 25 x 3 ZN
	4581046	6	WASHER SPRING M8 x 3/32 x 3/32

RSTB PARTS LISTING

PANELS TO RSTB/VEHICLE	6151234	12	BOLT M8 x 1.25 x 25 Gd 8.8 BP
	4581063	20	WASHER FLAT M8 x 25 x 3 ZN
	6151032	8	NUT NYLOC M8 x 1.25
	4581046	4	WASHER SPRING M8 x 3/32 x 3/32
	6151256	8	SCREW BTN HD M6 x 16 SS
	6151549	2	NUT NYLOC M6 x 1.0 GR8.8 BTZP480
	4581304	8	WASHER FLAT M6 S/S
	4581082	2	WASHER FLAT M6 x 19 x 1.6 BLK ZN
	6151213	2	BOLT M6 x 1.0 x 20 Gd8.8 BZ
	4584295	2	WASHER FLAT M6 x 12 x 1.3 BLK ZN

TOW TONGUE	FOR VEHICLES FITTED WITH PARKING SENSORS		
	6522997	1	DIFFUSER PANEL LH
	6522996	1	DIFFUSER PANEL RH
	3131496R	1	RANGER WING RH
	3131496L	1	RANGER WING LH
	FOR VEHICLES WITHOUT PARKING SENSORS		
	6522999	1	DIFFUSER PANEL LH
	6523000	1	DIFFUSER PANEL RH
	3131495R	1	RANGER WING RH
	3131495L	1	RANGER WING LH
	4761170	1	TOW TONGUE 45 DEG
	55010	1	TOW BAR PULL PIN
	55020	1	SPRING CLIP
	180302	10	CABLE TIE 200MM

TRAILER WIRING

The following trailer wiring solutions can be purchased from ARB. Purchase the main wiring harness with ECU (Part no. 3600010) in conjunction with the appropriate socket and tail listed below. Alternatively, this product is compatible with the factory trailer wiring solution.



To install this loom, a crimping tool suitable for crimping contact type size 16 Deutsch pins is required. Suitable crimping tools can be purchased from auto electrical wholesalers as shown.



APPLICATION	PART NO.	QTY	DESCRIPTION
TRAILER WIRING	3600010	1	RSTB WIRING INCLUDING ECU
	3600020	1	RSTB SOCKET & TAIL 7 PIN FLAT
	3600030	1	RSTB SOCKET & TAIL 12 PIN FLAT
	3600040	1	RSTB SOCKET & TAIL 7 PIN ROUND LRG
	3600050	1	RSTB SOCKET & TAIL 7 PIN ROUND SML

OPTIONAL ACCESSORIES

The following ARB accessories can be fitted to this product:

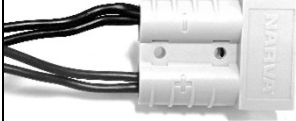
APPLICATION	PART NO.	QTY	DESCRIPTION
OPTIONAL ACCESSORIES	171403	1	ARB AIR LINE FITTING
	10600030	1	ARB TRAILER CAMERA KIT
	58X22/A	1	RECOVERY HITCH AND SHACKLE
	6594050	1	50 AMP ANDERSON PLUG
			
AIR LINE FITTING	TRAILER CAMERA KIT	RECOVERY HITCH	ANDERSON PLUG

GENUINE ACCESSORIES REMOVAL

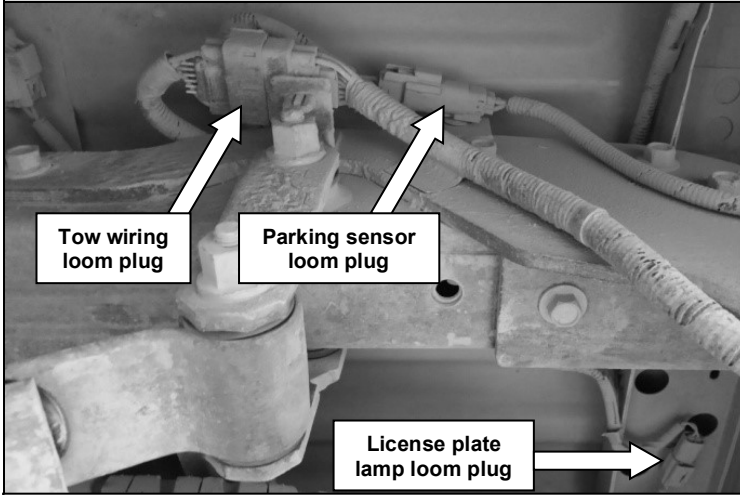

For vehicles fitted with parking sensors and/or a trailer plug:

1. Disconnect the parking sensor, tow wiring and license plate lamp looms from the vehicle at the locations shown.

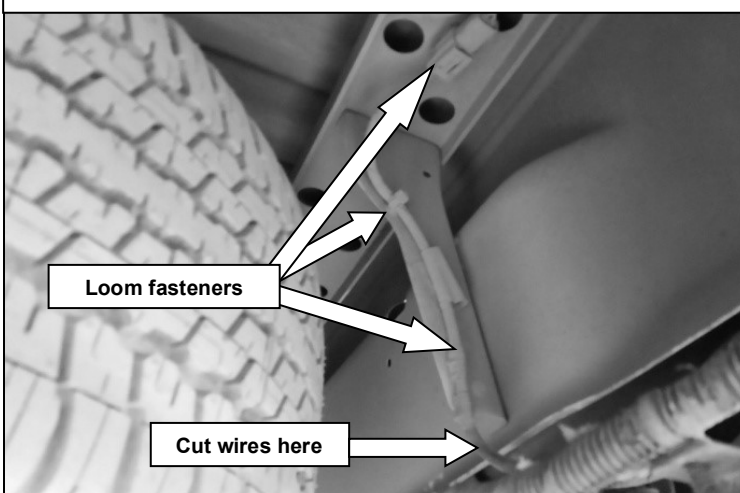

2. Disconnect loom for license plate lamp from vehicle by removing the 3 loom fasteners as shown.
3. Cut the license plate lamp loom at the point indicated in the photo and set loom aside for later use.

Warning: Ensure vehicle lights are turned off before cutting wires.

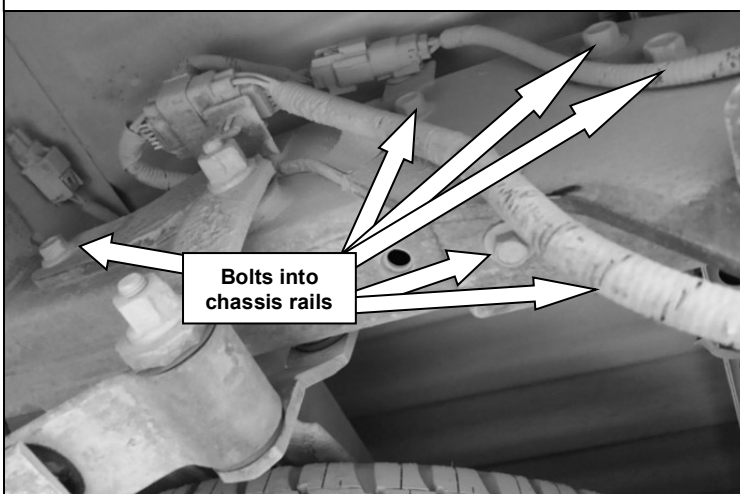

For vehicles fitted with a bumper/tow bar:

4. Disassemble the factory bumper bar and tow bar from the vehicle together by removing 6 M12 bolts from each chassis rail as shown.

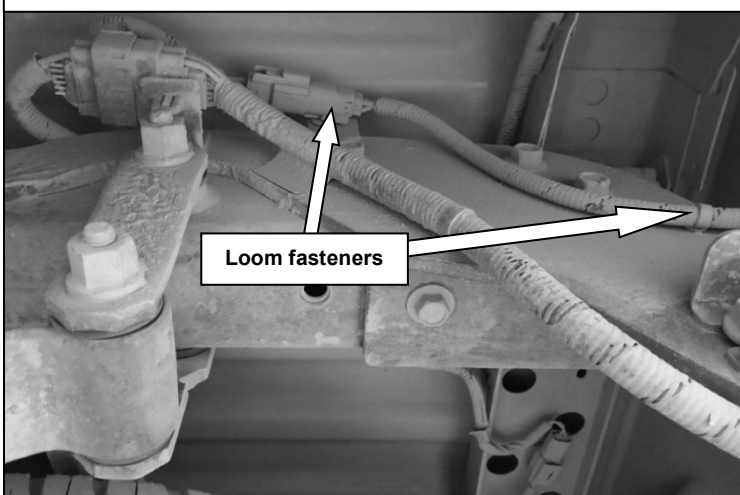

For vehicles fitted with parking sensors:

5. Remove the 2 loom fasteners from the tow bar for the parking sensor loom as shown.

GENUINE ACCESSORIES REMOVAL

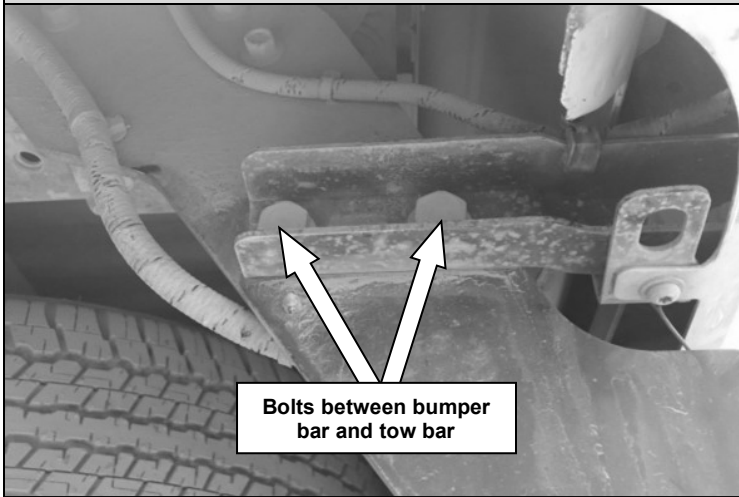

For vehicles fitted with a bumper/tow bar:

6. Disassemble the bumper bar from the tow bar by removing 2 M12 bolts from each side as shown.

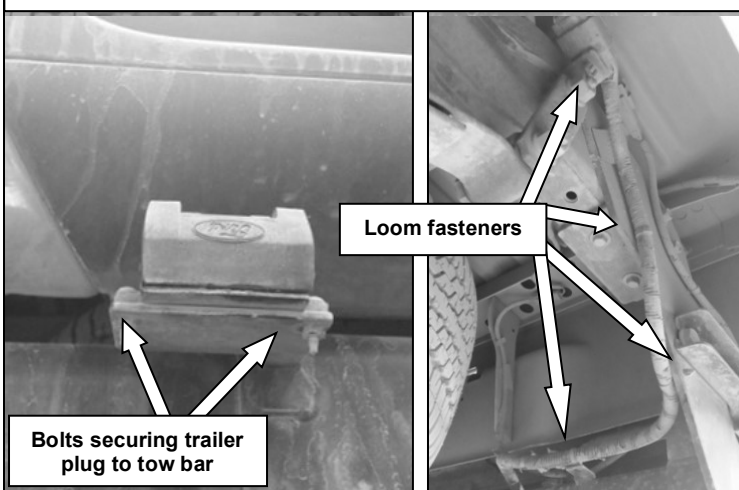

For vehicles fitted with a trailer plug:

7. Remove 4 loom fasteners from the tow bar on the trailer wiring loom as shown.
8. Disconnect the trailer plug from the tow bar by removing 2 bolts. Place the plug to the side where it will not be damaged during fitment of the Rear Step Tow Bar (RSTB).

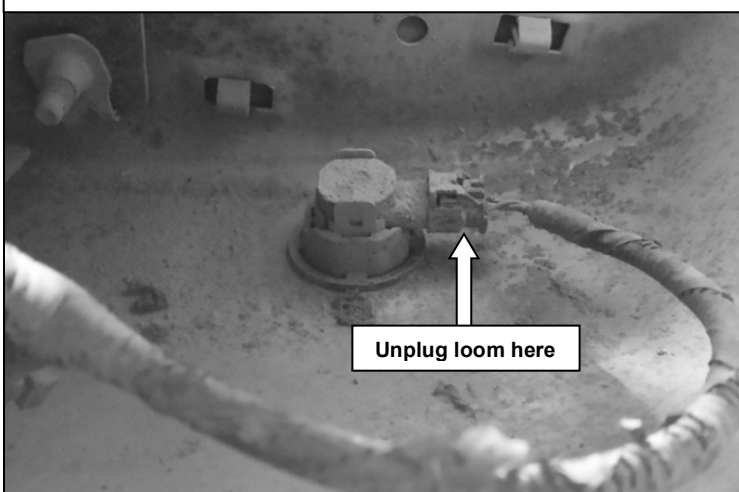

For vehicles fitted with parking sensors:

9. Carefully unplug the parking sensor loom from the 4 parking sensors and 2 license plate lamp connections in the bumper bar. Leave sensors and housings in the bumper bar at this stage.
10. Remove the parking sensor loom from the bumper bar by removing 8 loom fasteners. Place loom to one side for later use.



11. Remove the spare wheel from beneath the tub using the wheel nut wrench and jack handle pieces supplied with the vehicle. Insert as shown through the access slot above the number plate position and rotate counter-clockwise to release the wheel.

VEHICLE/RSTB WIRING

A trailer wiring solution that incorporates a smart ECU is available for this vehicle. To fit this solution, the rear vehicle wiring harness must be cut and high quality, waterproof Deutsch connectors installed to provide signal pickup points for the ECU.

To install this loom, a suitable crimp tool is required. Refer to Page 4 for more details about the crimp tool.

Follow the steps below to install the trailer wiring solution:

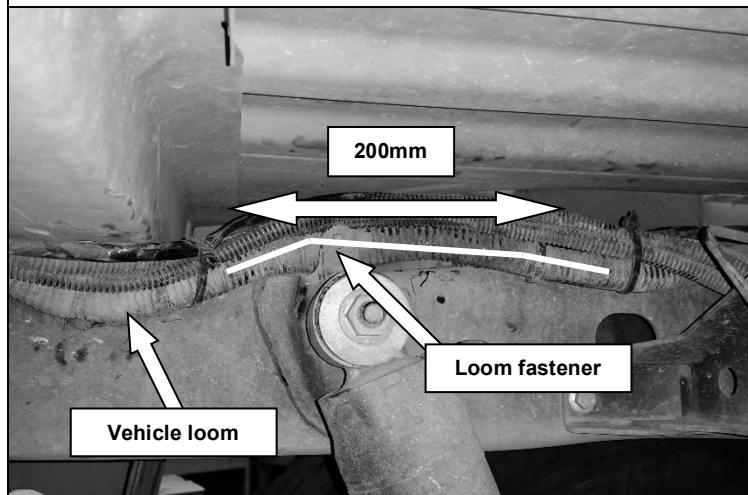

12. Locate the vehicle loom on the left hand chassis rail near shock mount as shown. Remove tape if present and expose 200mm of the following coloured wires from the split corrugated tubing:

- Green w/ Blue trace
- Green w/ Brown trace
- Blue w/ Brown trace
- Purple w/ Brown trace
- Purple w/ Green trace

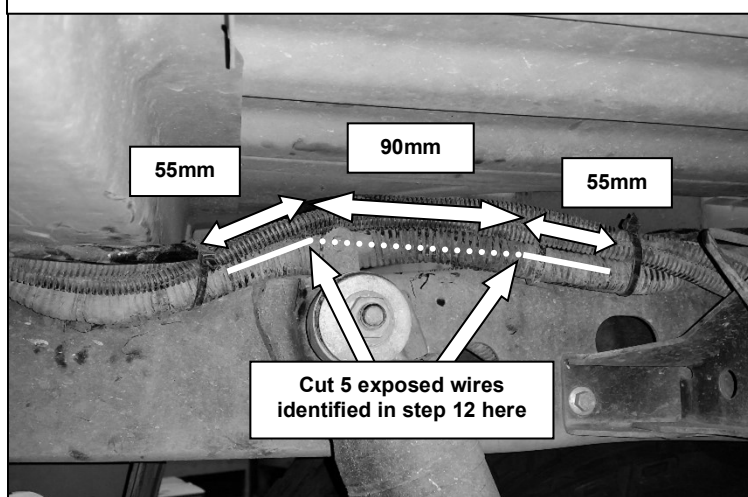

13. Cut a 90mm section from the centre of the 5 exposed wires. This will leave 55mm of wire before they re-enter the corrugated tubing at each end.

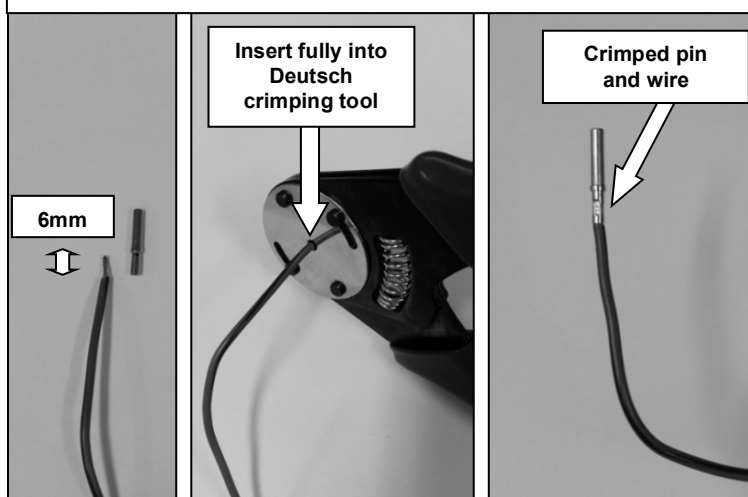

14. Remove 6mm of the plastic insulation coating from the end of each newly cut wire.

15. Insert each wire into the shorter end of a metal Deutsch pin.

16. Insert the longer end of the metal Deutsch pin into a crimping tool and crimp the wire and pin together as shown.

VEHICLE/RSTB WIRING

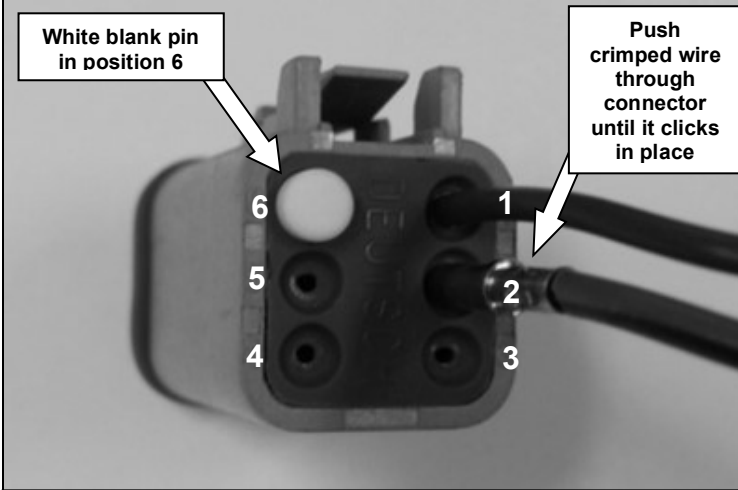

17. Insert one set of wires into a male 6-pin connector from the back in the following order:

Pin position	Wire colour
1	Green w/ blue trace
2	Green w/ brown trace
3	Blue w/ brown trace
4	Purple w/ brown trace
5	Purple w/ green trace

Note: Pin positions are shown on the back of the connector.

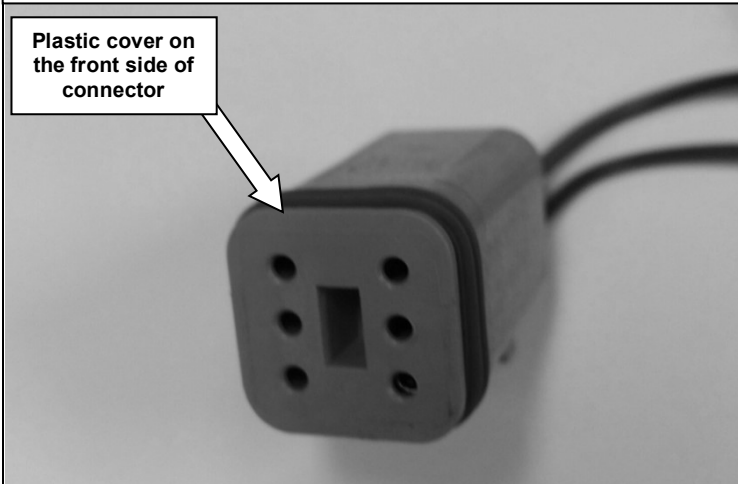

18. Insert the white blank pin into position 6 as shown in the previous step.
19. Insert the plastic cover to the front of the connector as shown.
20. Repeat steps 17-19 for the other connector.

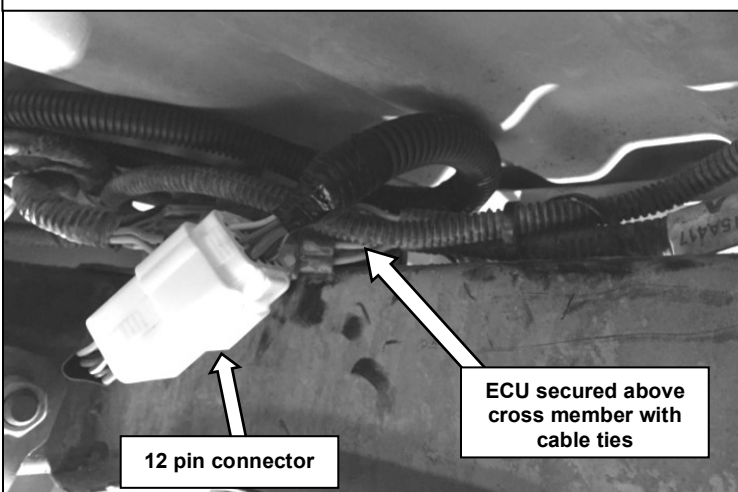

21. Position ECU on top of cross member beneath tub as shown. Secure using the ECU mounting holes and cross member holes with 2 cable ties.
22. Connect the ECU unit to the RSTB wiring harness using the large 12 pin connector.

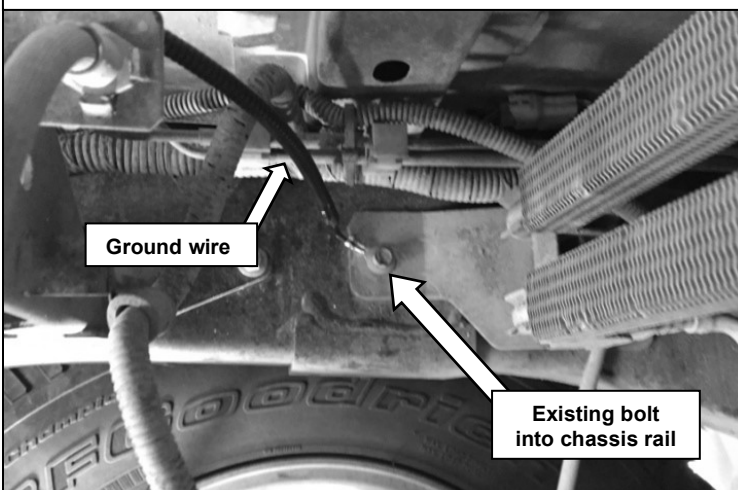

23. Connect the ground wire of the RSTB harness to the bolt on the left chassis rail towards the centre of the vehicle as shown.

VEHICLE/RSTB WIRING

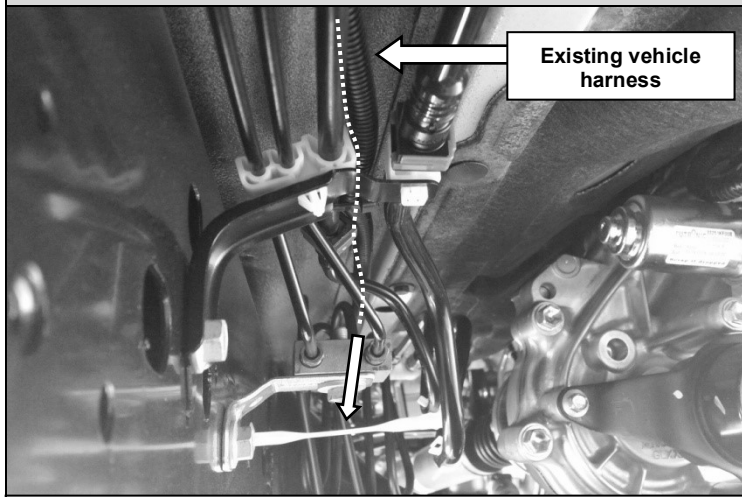

24. Route the positive supply wire to the front of the vehicle following the existing vehicle harness along the left chassis rail.

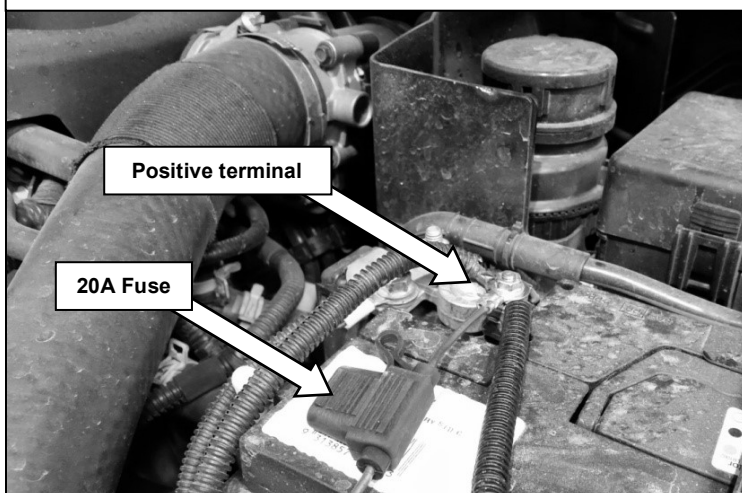

25. Continue routing the positive supply wire through the engine bay to the battery.
26. Connect the positive supply wire to the positive terminal of the battery using the existing bolt as shown.

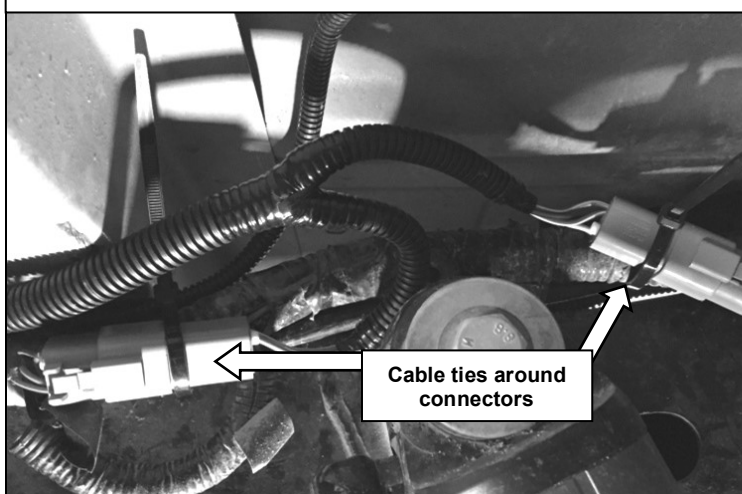

27. Connect the RSTB wiring harness to the 2 male 6-pin connectors.
- Note: The RSTB wiring harness is not polarity sensitive in this region so the male 6-pin connectors can be connected to either female connector.**
28. Ensure vehicle tail lights function correctly.
29. Fasten the connectors to the vehicle loom using the cable ties provided.



30. Re-wrap the un-cut wires with the existing split corrugated tubing and new tape.
31. Tidy and fasten all wiring using the cable ties provided.
- Warning: Make sure all wires are securely fastened away from any hot, sharp or moving surfaces. Do not fasten wiring harness to fuel or brake lines.**
32. Ensure vehicle tail lights function correctly.

PREPARE REAR STEP TOW BAR (RSTB)

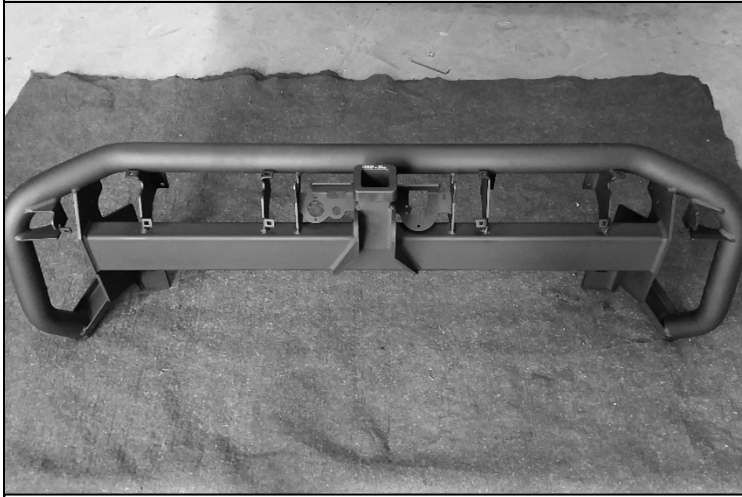

33. Place the RSTB on a flat surface that will not damage its coating as shown.

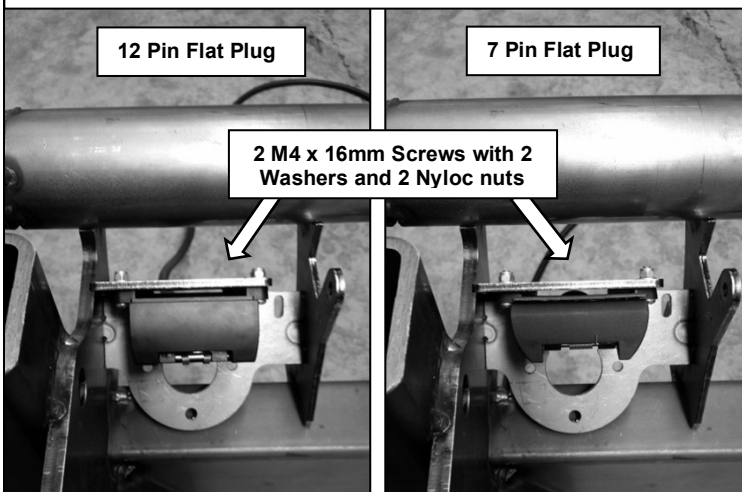

For fitment of flat trailer plugs:

34. Using the appropriate mounting holes as shown and fasteners supplied with the trailer plug, attach the trailer plug to the trailer plug bracket on the RSTB.

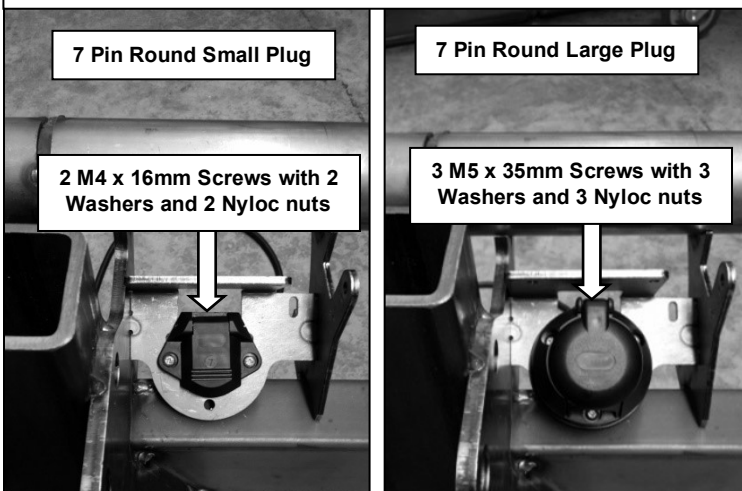

For fitment of round trailer plugs:

35. Using the appropriate mounting holes as shown and fasteners supplied with the trailer plug, attach the trailer plug to the trailer plug bracket on the RSTB.

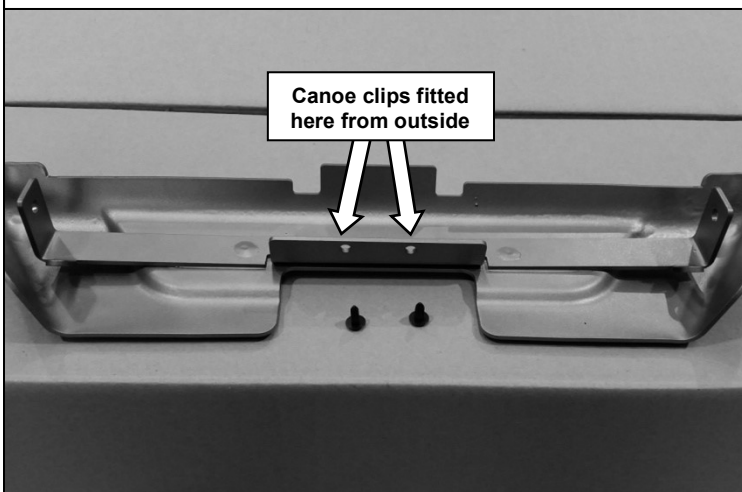

36. Fit 2 plastic canoe clips to the lift up panel using the holes as shown.

PREPARE REAR STEP TOW BAR (RSTB)

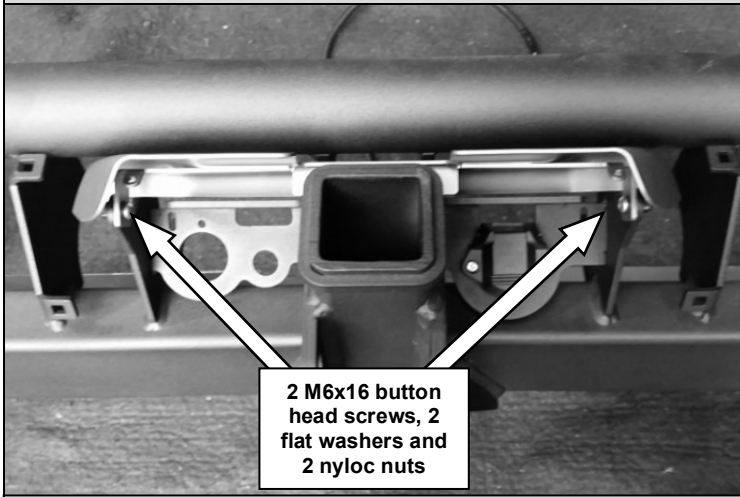

37. Attach the lift up panel to the pivot plates on the RSTB using 2 M6x16 button head screws, 4 M6 flat washers and 2 M6 nyloc nuts.

38. Tighten the screws enough to ensure the lift up panel is centralised with minimal sideways movement, but still able to lift up and down freely.

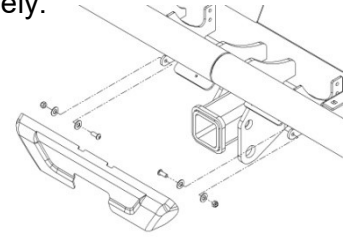

39. Rotate the RSTB 90° so it is now resting flat on the ground as shown.

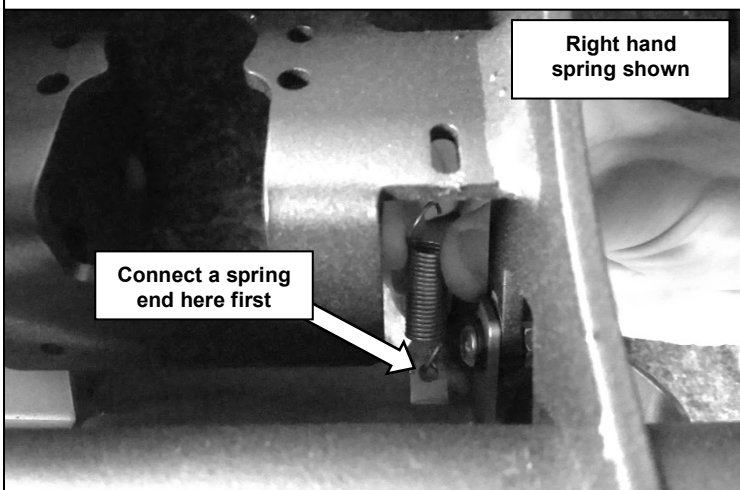

40. Connect 2 springs between the RSTB and lift up panel. From above, first connect one end of each spring to the lift up panel as shown.

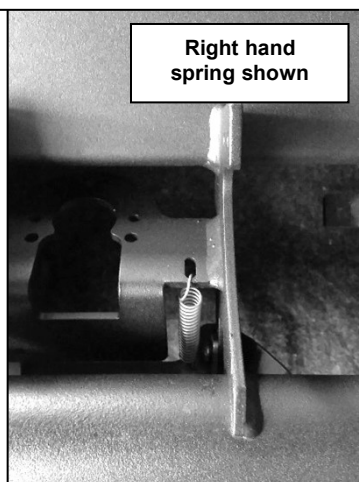
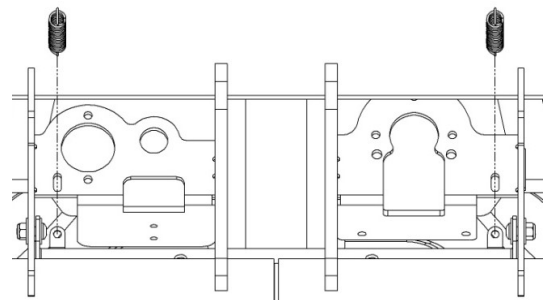

41. Using pliers, stretch the free end of each spring up to the bracket on the RSTB as shown.



Warning: Safety glasses should be worn for this operation as the spring may slip off the pliers if not clamped tightly

PREPARE REAR STEP TOW BAR (RSTB)

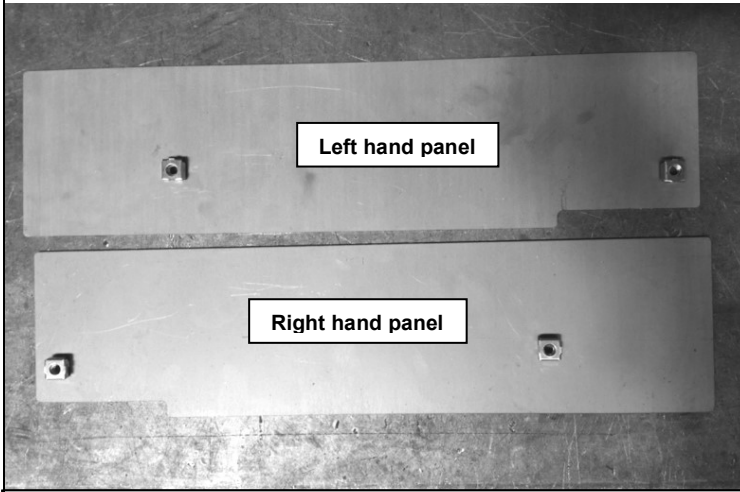

42. Fit 4 short-leg M6 caged nuts to the stone guard panels as shown.

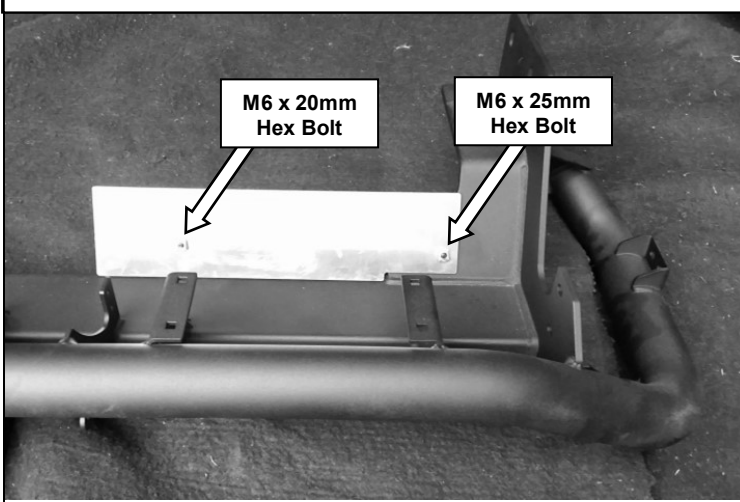

43. Fix both stone guard panels to the RSTB using 2 M6x20 hex head bolts, 2 M6x25 hex head bolts, 4 M6 spring washers and 4 M6 flat washers. Tighten to the specified torque.



M6 X 1.0 - 9 Nm.

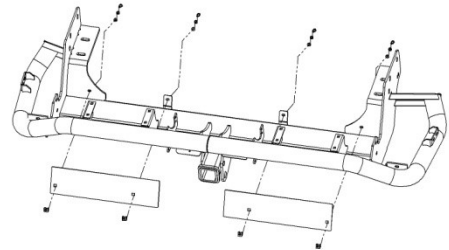

RSTB TO VEHICLE



44. With the assistance of other people or a lifting device, lift the RSTB up beneath the chassis rails aligning the threaded holes in the side of the chassis with those in the vertical surfaces of the RSTB.

Note: Take care to ensure the trailer plug wiring is not damaged during this step.

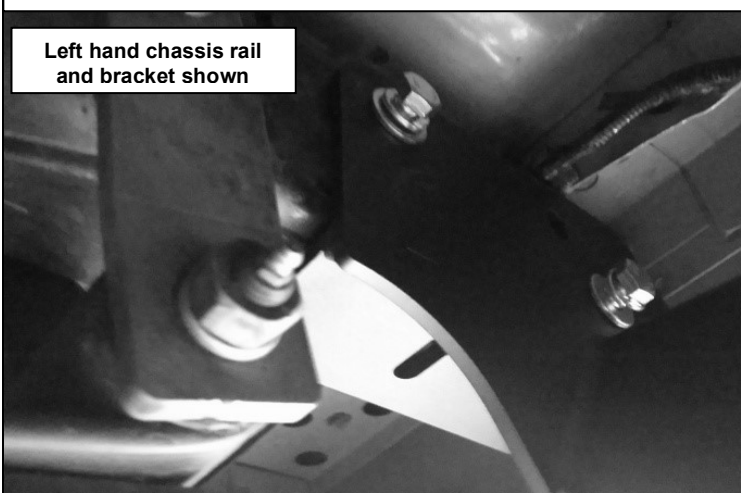

Left hand chassis rail and bracket shown

45. Fix the vertical plates of the RSTB over the threaded holes in each chassis rail using 2 M12x1.75x40 (coarse pitch) hex head bolts, 2 M12 spring washers and 2 M12 flat washers per chassis rail. Leave finger tight at this stage.

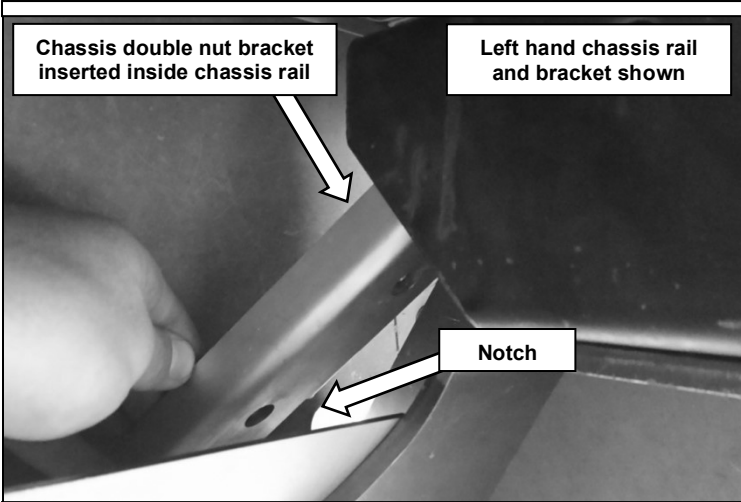
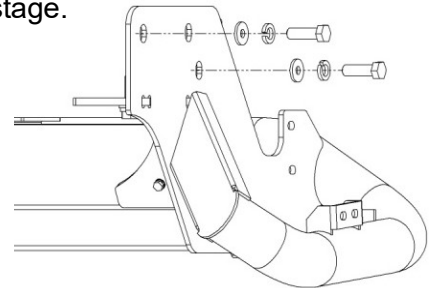

Chassis double nut bracket inserted inside chassis rail

Left hand chassis rail and bracket shown

Notch

46. Insert one chassis double nut plate inside each chassis rail as shown. Position over existing holes.

Note: The notch in the chassis double nut plate should face the outer rear corner of the vehicle.

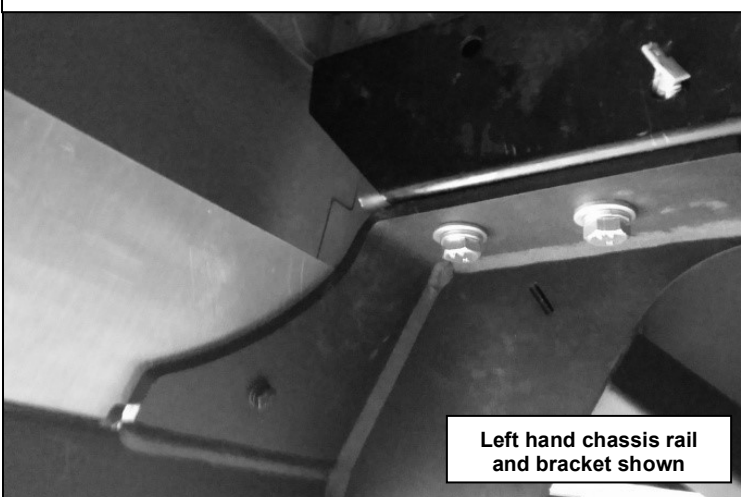

Left hand chassis rail and bracket shown

47. Place 2 M12x1.25x40 (fine pitch) hex head bolts, 2 M12 spring washers and 2 M12 flat washers per chassis rail through the RSTB plate as shown. Attach using the chassis double nut plates placed inside the chassis rails in the previous step. Leave finger tight at this stage.

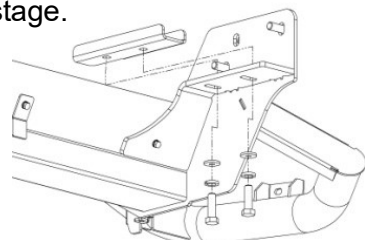

RSTB TO VEHICLE

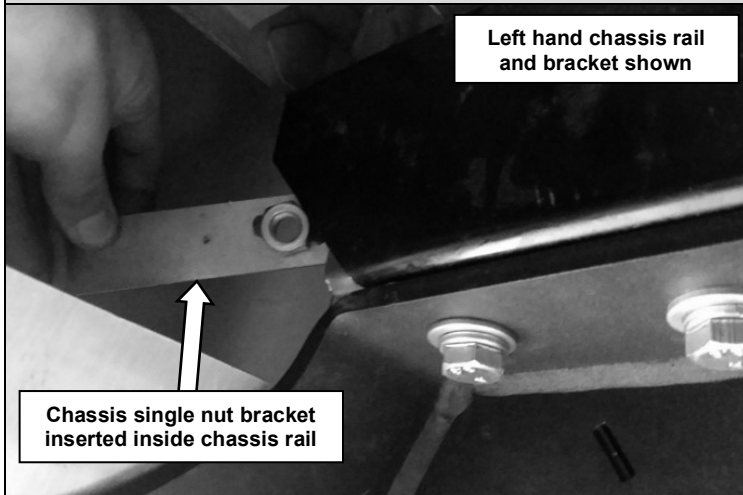

48. Insert 1 chassis single nut plate inside each chassis rail on the outer face and hold in place.

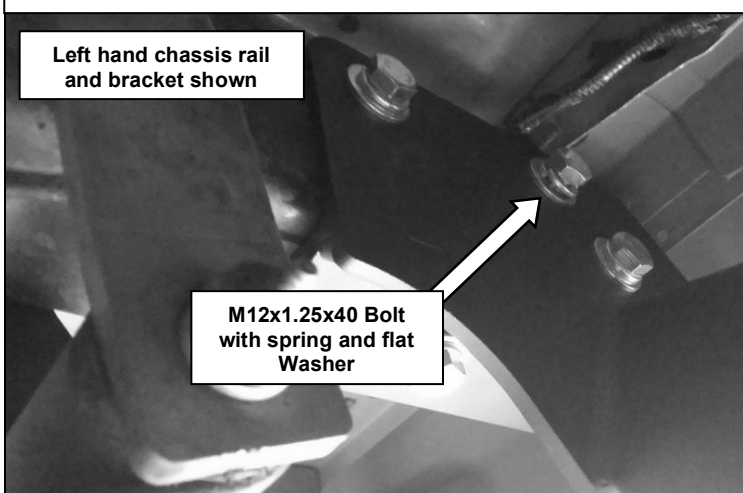

49. Place 1 M12x1.25x40 (fine pitch) bolt with 1 M12 spring washer and 1 M12 flat washer in each chassis rail through the upper-rear-most holes. Attach to the chassis single nut plate and leave finger tight.

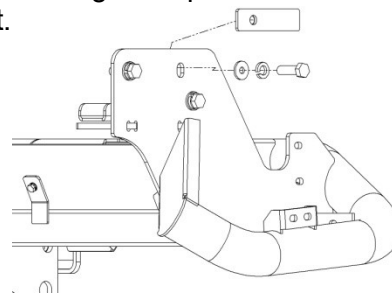

50. Position the bar so there is even spacing to the vehicle and tighten all fasteners to the specified torque.

 M12 X 1.75 - 77 Nm.

 M12 X 1.25 - 95 Nm.

LICENSE PLATE TO VEHICLE

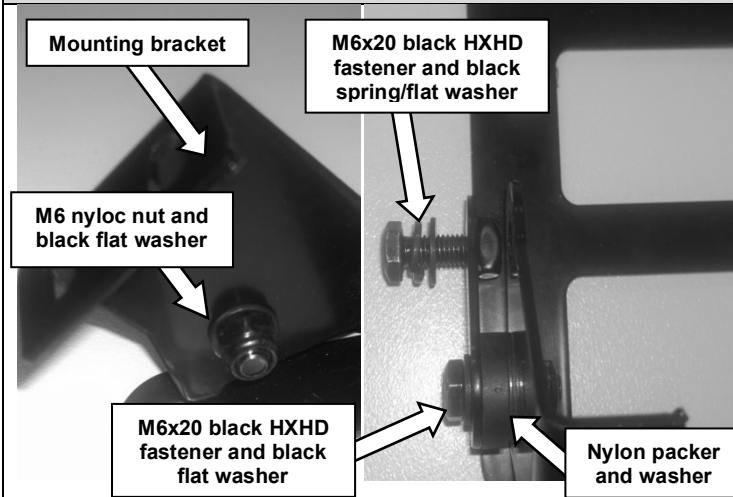

51. Assemble license plate bracket as shown taking note of mounting bracket orientation. Repeat step for opposite side of license plate bracket.
52. Tighten the screws enough so the brackets can be rotated by hand but not freely by themselves.
53. Insert M6X20 HXHD fastener, with spring and flat washer as shown. Do not fully tighten at this stage as this is for locking number plate in upright position.

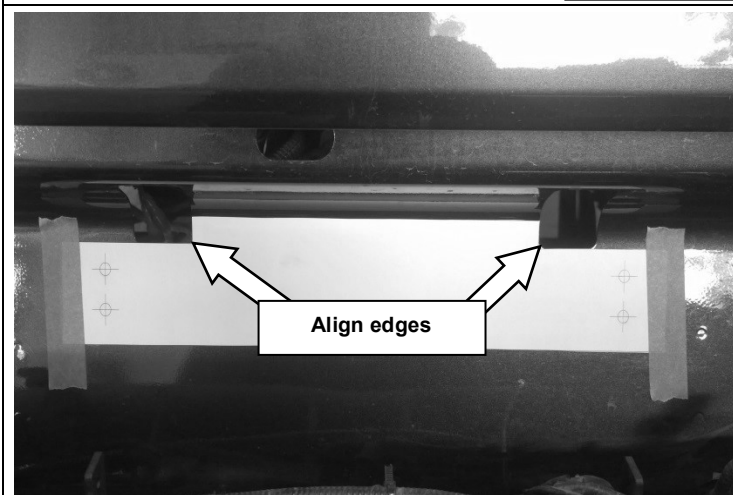

54. Place the number plate drilling template on the rear panel of the tub as shown. When aligned use masking tape to hold in place
55. Center punch the 4 holes, remove template and drill to $\text{\O}6.5\text{mm}$ and de-bur each holes to remove all sharp edges.
56. Treat all raw edges with a rust preventative paint

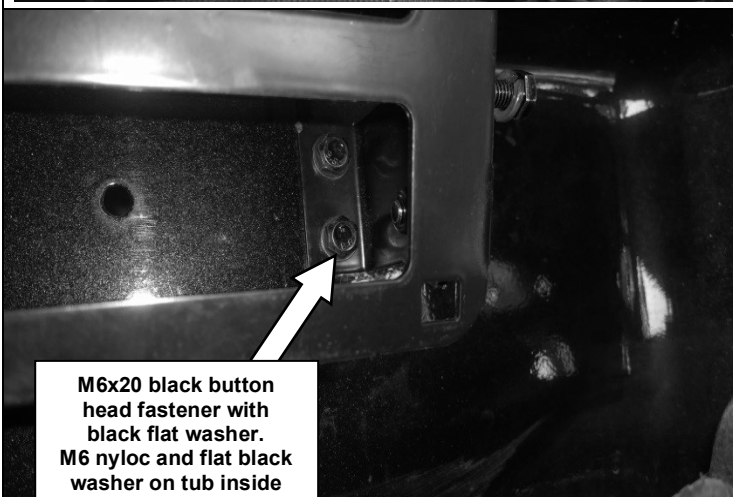

57. Fix the license plate assembly to the beaver panel using 4 M6x20 HXHD fasteners, 8 M6 flat washers (black), and 4 M6 nyloc nuts as shown.
58. Tighten all screws to the specified torque.

 M6 X 1.0 - 9 Nm.



59. Attach the license plate to the license plate bracket using 4 5.2x16 screws into the plastic snap-in large grommets.

LICENSE PLATE TO VEHICLE

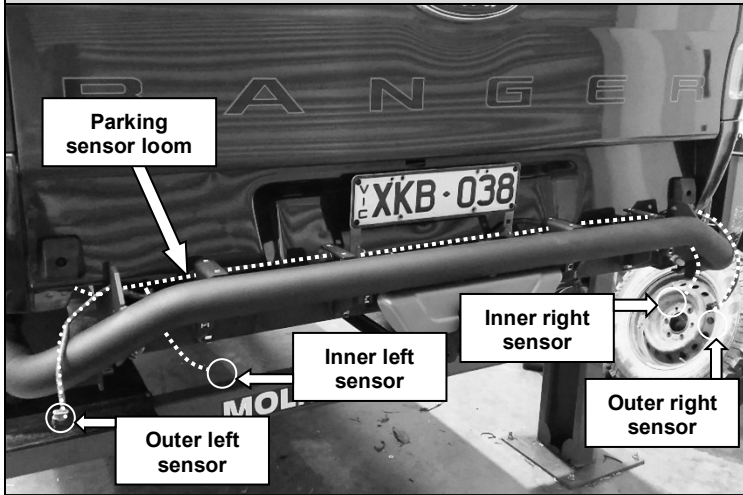

For vehicles fitted with parking sensors:

60. Route the parking sensor loom through the RSTB and position the parking sensor connectors in appropriate positions as shown.

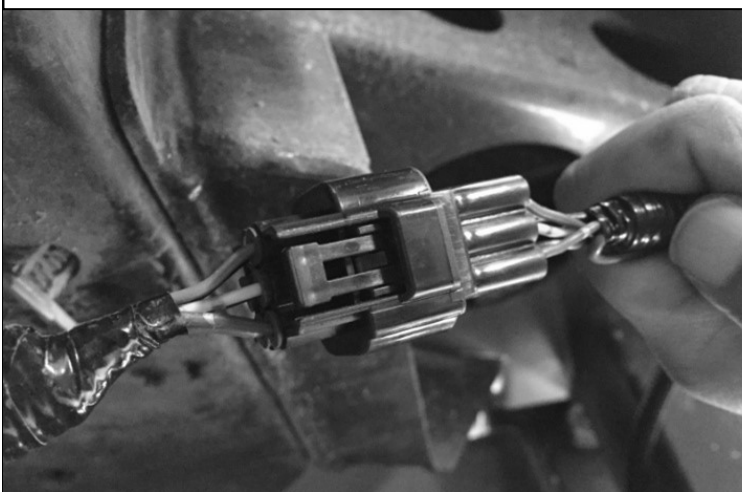

61. Route the trailer plug loom through the RSTB and attach to the appropriate connector on the RSTB wiring harness as shown.
62. Ensure all trailer tail lights function normally.

Note: Test that the trailer park, brake and reverse lights function normally. Also test the left and right indicators along with the hazard setting.



63. Tidy and fasten all wiring using cable ties and the slots in the RSTB brackets, as well as existing fastening locations.

Warning: Make sure all wires are securely fastened away from any hot, sharp or moving surfaces. Do not fasten wiring harness to fuel or brake lines.

64. Ensure trailer tail lights function normally as per step 57.

STEP PLATE TO RSTB

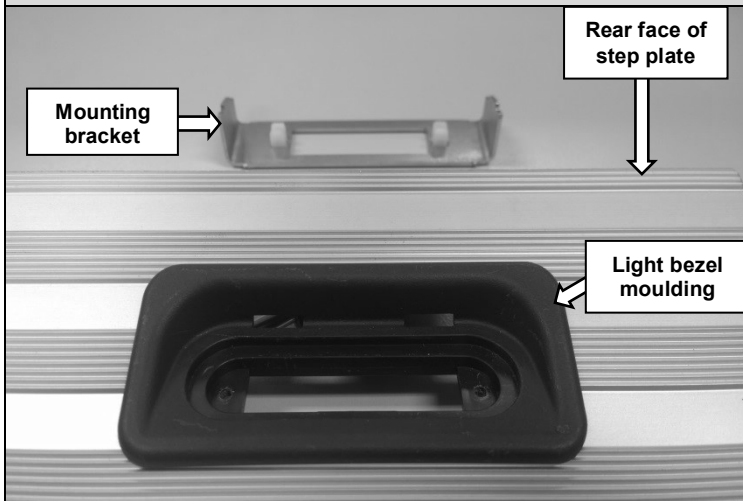

65. Push 2 plastic snap-in small grommets through the 2 holes in the LED mounting bracket as shown. Install the grommets from the underside of the bracket.

66. Fit the light bezel moulding to the step plate extrusion as shown with the deep section facing towards the rear face of step plate.

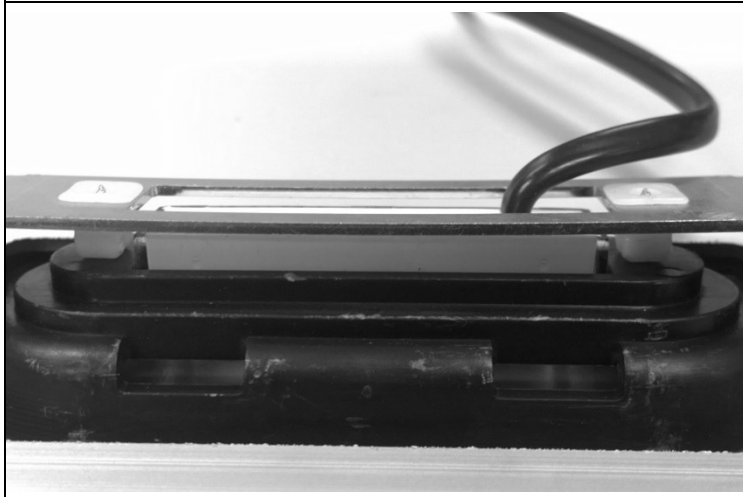

67. **Remove the foam ring from the LED lamp and discard.**

68. Place the LED lamp in the light bezel moulding and fix to the mounting bracket using the screws supplied in the lamp kit.

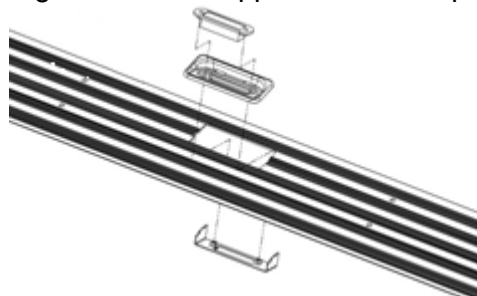

69. Fit the clear plastic plugs supplied in the lamp kit to the LED lamp above the screws.

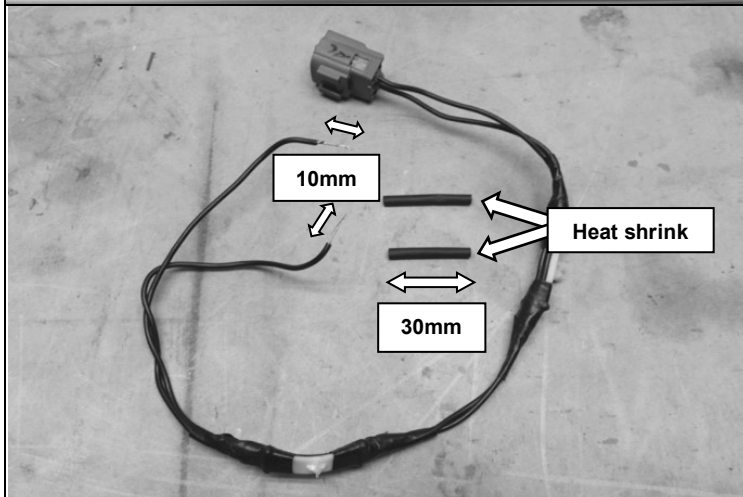

70. Remove 10mm of the plastic insulation coating from the license plate lamp loom that was cut and set aside in Step 3.

71. Insert a 30mm piece of heat shrink over each wire as shown.

STEP PLATE TO RSTB

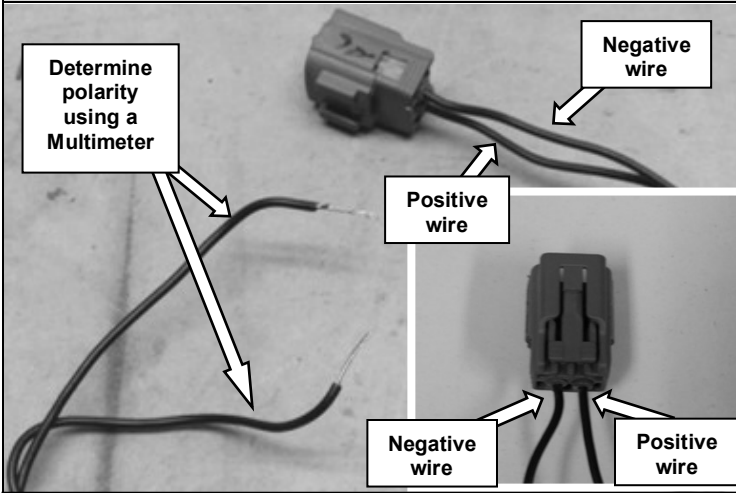

For vehicles without parking sensors:

72. Identify the positive and negative wires from the license plate lamp loom using this photo as a reference.
73. Use a multimeter to help identify the wires at the cut ends as they may be hard to trace from the connector under the tape.

Note: The LED lamp is polarity sensitive so it is important to identify and solder the correct wires together.

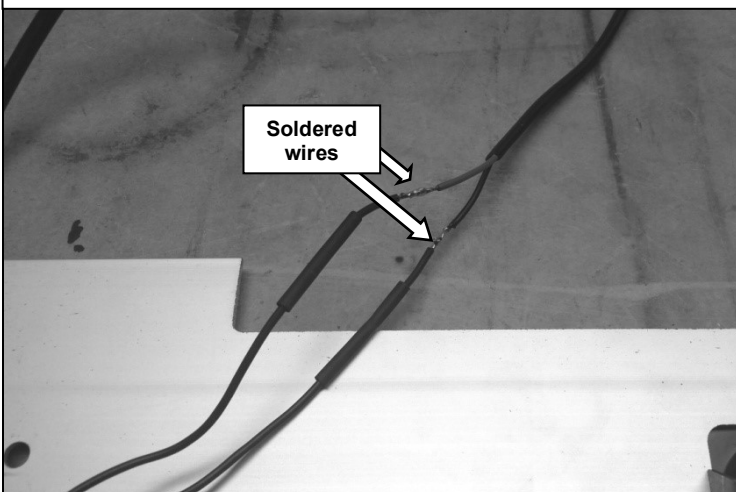

For vehicles without parking sensors:

74. Using a soldering iron and solder, join the LED lamp wires to the license plate lamp loom using the colours in the table below:

LED Lamp wire	License plate loom
Red	Positive
Black	Negative

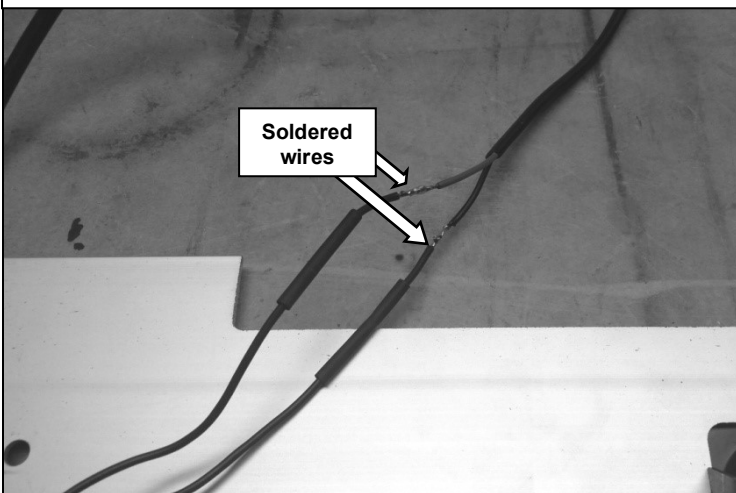

For vehicles fitted with parking sensors:

75. Using a soldering iron and solder, join the LED lamp wires to the license plate lamp loom using the colours in the table below:

LED Lamp wire	License plate loom
Red	Yellow w/ purple trace
Black	Black w/ white trace

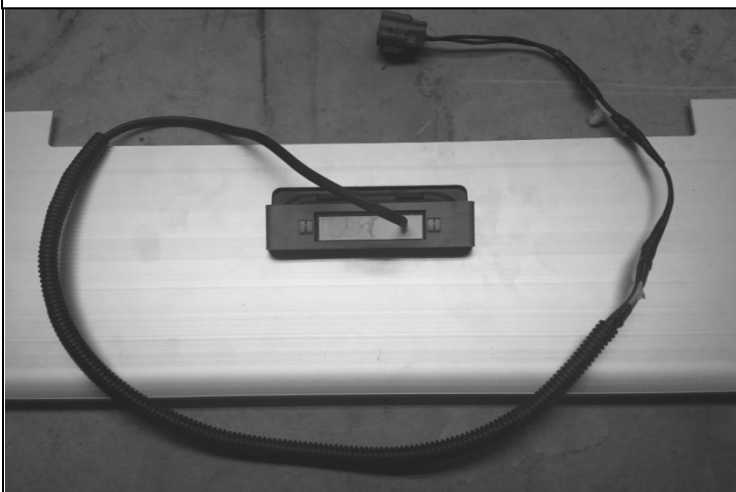

76. Place the heat shrink over the soldered wires and use a heat gun to shrink in place.
77. Further protect each join with corrugated tubing and insulation tape.

STEP PLATE TO RSTB

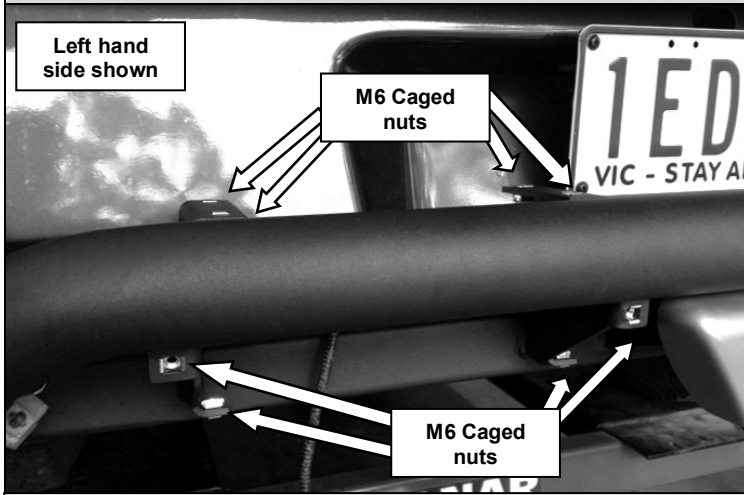

78. Fit 16 long-leg M6 caged nuts to the RSTB. Fit 8 caged nuts to the left hand side as shown and 8 caged nuts to the right hand side.



79. Attach the step plate extrusion to the RSTB using 8 M6x16 button head screws taking care not to damage the LED lamp wire.

NOTE : Do not install washers under the 8 M6 button head screws that are fixing the step plate extrusion to the RSTB



80. Route the LED lamp loom through the RSTB to its fastening point identified in Step 1 and connect to the existing connector.

81. Ensure the license plate LED lamp functions correctly.



82. Tidy and fasten all wiring using the cable ties provided.

Warning: Make sure all wires are securely fastened away from any hot, sharp or moving surfaces. Do not fasten wiring harness to fuel or brake lines.

83. Test the LED lamp as per step 75 to confirm correct operation.

PREPARE RSTB/VEHICLE FOR PANELS

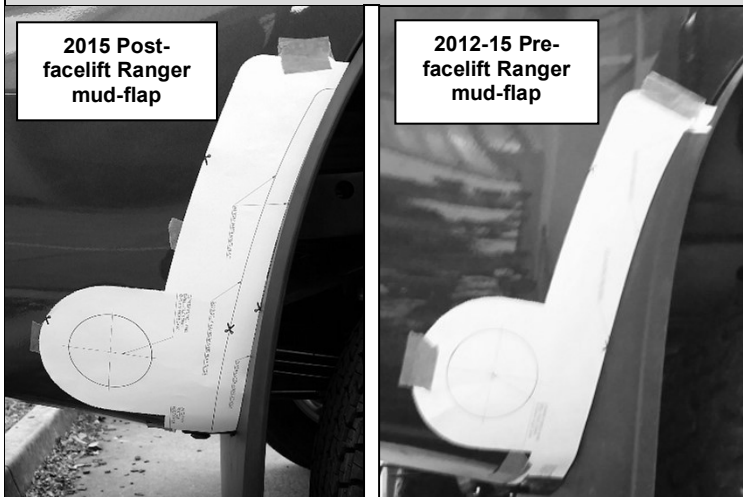

84. Cut along the appropriate line on the cutting template depending on the vehicle model and place on the right hand rear side panel of the tub aligning it with the mud flap and bottom edge of the tub. Use masking tape to hold in place.

Note: Confirm mud-flap prior to using template. Refer to template (#3789361) for further details.

85. Mark the centre of the cutting hole on the rear side panel and then remove the template.



86. Using a $\text{\O}70\text{mm}$ hole saw, drill through the rear side panel using the mark from the previous step as the centre point of the hole.



87. Repeat steps 78 to 80 for the left hand rear side panel using the opposite side of the template.



88. De-bur each hole to remove sharp edges.

89. Treat raw edges with a rust preventative paint.

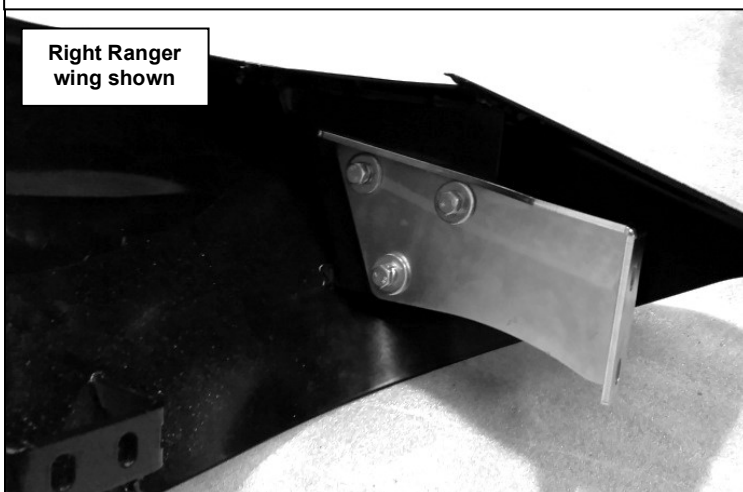

90. Fix a wing mount bracket to each Ranger wing using 3 M8x1.25x25 hex head bolts, 3 spring washers, 3 flat washers and a wing triple nut plate. Orientate each bracket as shown. Leave bolts finger tight at this stage

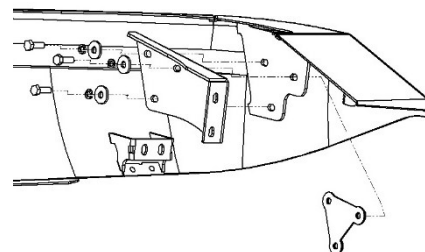

PREPARE RSTB/VEHICLE FOR PANELS

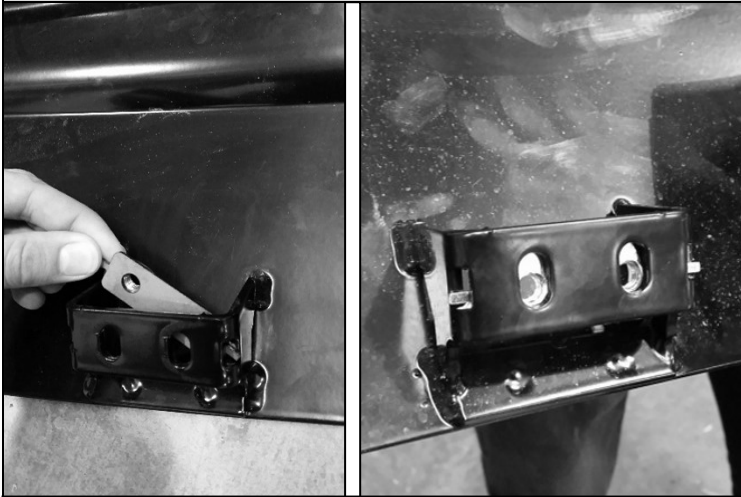

91. Place a wing double nut plate inside the middle bracket of each Ranger wing as shown.

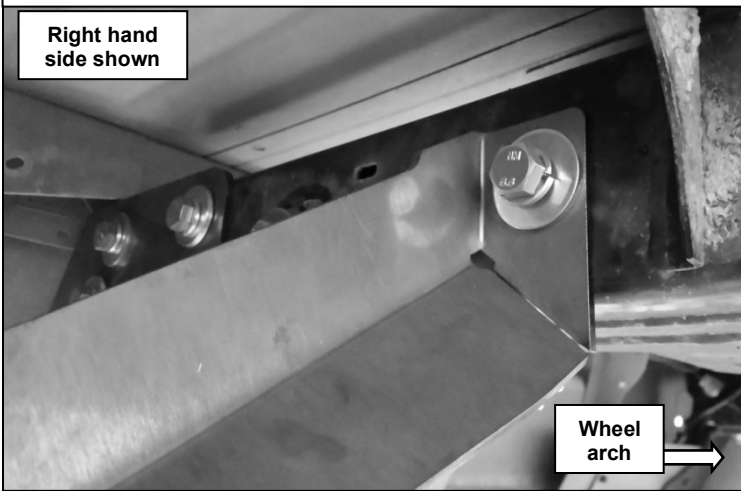

92. Position the 2 remaining wing mount struts under the tub and fix to the threaded holes in the chassis rails using 1 M12x1.75x40 hex head bolt, 1 M12 spring washer and 1 M12 flat washer for each bracket. Leave finger tight at this stage.

Note: Struts should be positioned with leading edge towards wheel arch as shown.

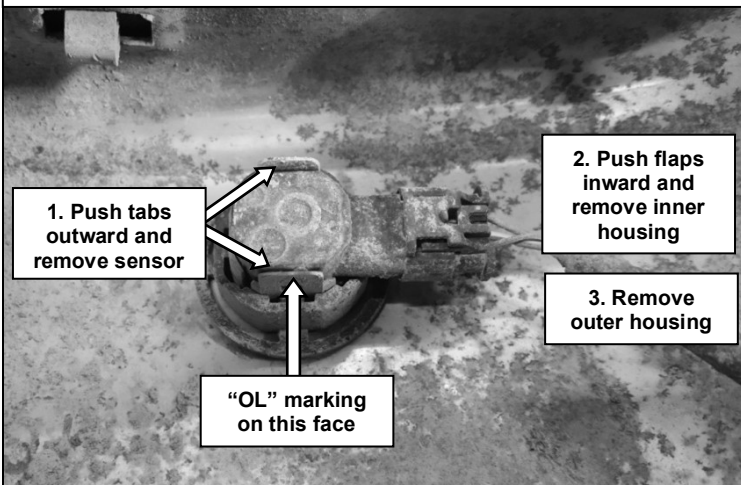
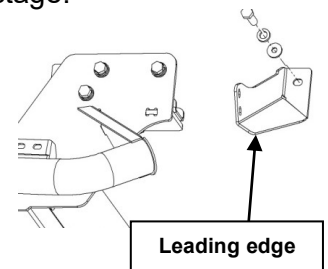

For vehicles fitted with parking sensors:

93. Remove the outer right (marked as "OR") parking sensor assembly from the factory bumper bar. To do this, first unclip the sensor and then remove the sensor housing and retainer.

Note: Take care to not damage housings when pushing tabs to release clips.

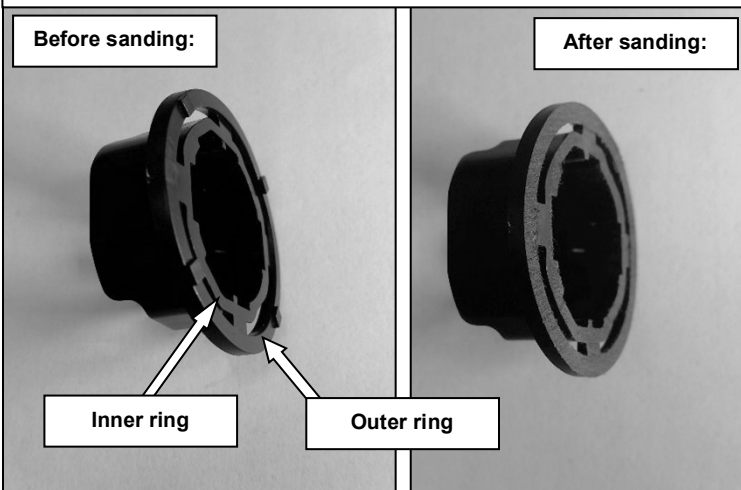

For vehicles fitted with parking sensors:

FOR OUTER LEFT AND OUTER RIGHT SENSOR RETAINERS ONLY:

94. Remove material from the face of the retainers using 120 grit sandpaper on a flat surface. Sand until the outer ring is level with the inner ring as shown.

CAUTION: Take care not to remove excess material as this will reduce the clamping performance of the assembly.

PANELS TO RSTB/VEHICLE

Right Ranger wing shown

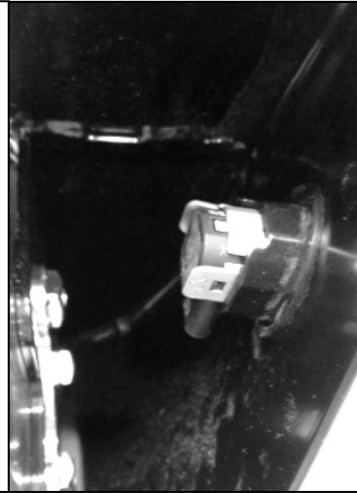

For vehicles fitted with parking sensors:

95. Insert the inner and outer parking sensor housing into the rear right Ranger wing as shown. The inner housing will click into place.
96. Insert the sensor into the housing assembly with the connector facing the outside of the Ranger wing as shown. The sensor will click into place.

Right diffuser panel shown

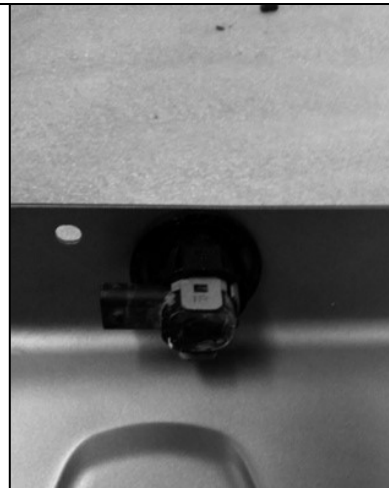
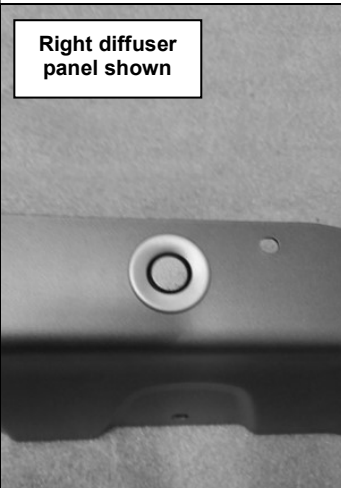

For vehicles fitted with parking sensors:

97. Repeat steps 87-90 for the remaining 3 sensors ("IL" – Inner left, "OL" – Outer left, "IR" – Inner right). Take care to ensure the orientation and position of each sensor is the same as that in the factory bumper bar.
 - The **outer** sensors are to be fitted to the Ranger wings.
 - The **inner** sensors are to be fitted to the diffuser panels.

Apply masking tape on this edge and inside face

Apply masking tape in this area at rear corner of vehicle

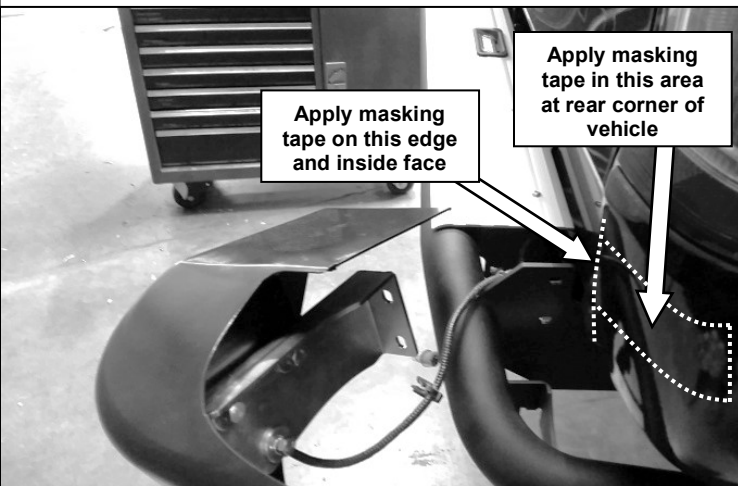

98. Position the Ranger wings next to the rear side vehicle panels.

Note: Take care not to damage the vehicle when positioning the Ranger wings. Protect the vehicle panel using masking tape in areas shown.

For vehicles fitted with parking sensors:

99. Connect the parking sensors to the parking sensor loom as the Ranger wings are positioned against the vehicle.

Right wing mount strut shown

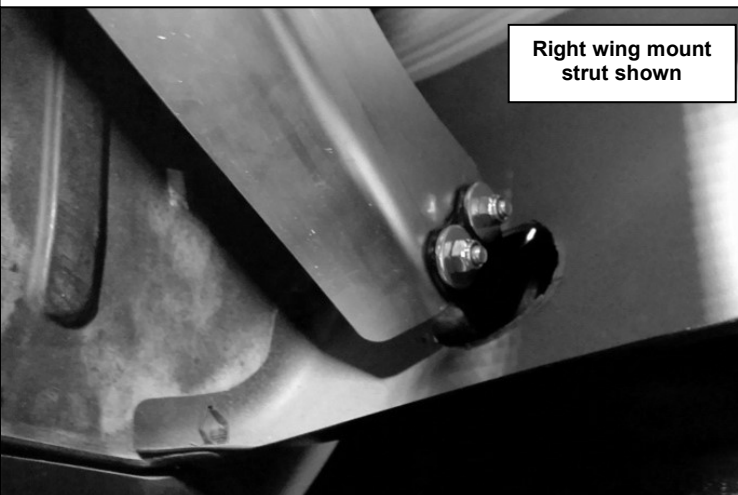

100. Pass the front bracket of each Ranger wing through the Ø70mm hole in the tub and fasten to the wing mount strut using 2 M8x1.25x25 hex head bolts, 4 M8 flat washers and 2 M8 nyloc nuts. Leave bolts finger tight at this stage.

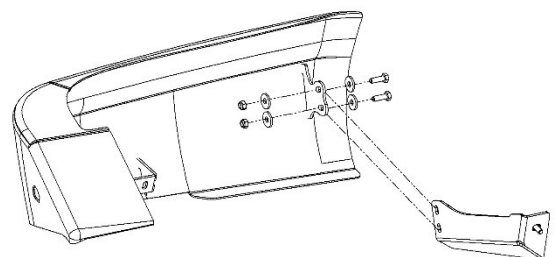

PANELS TO RSTB/VEHICLE

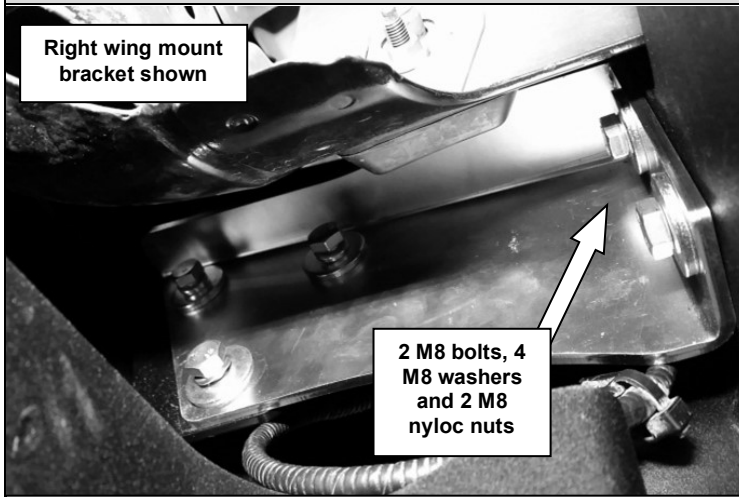

101. Fix the wing mount bracket of each Ranger wing to the RSTB using 2 M8x1.25x25 hex head bolts, 4 M8 flat washers and 2 M8 nyloc nuts. Leave bolts finger tight at this stage.



102. Fix the middle bracket of each Ranger wing to the RSTB tube using 2 M8x1.25x25 hex head bolts, 2 M8 spring washers, 2 M8 flat washers and the wing double nut plate already fitted. Leave bolts finger tight at this stage.

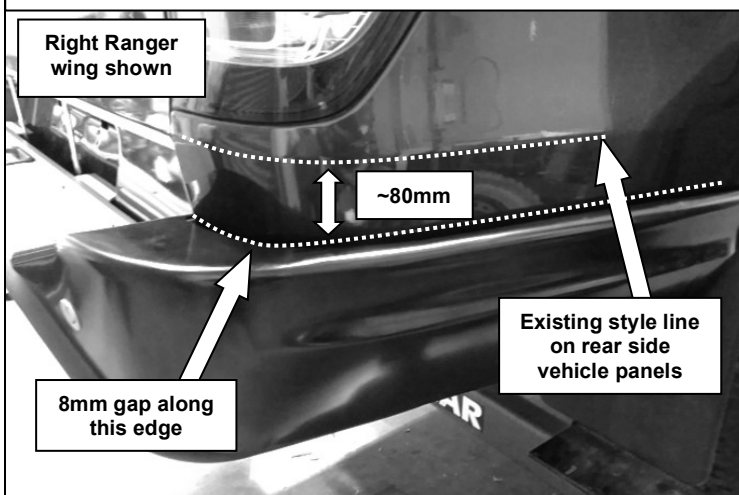

103. Position each Ranger wing so there is an even 6-8mm gap to the side vehicle panels.

Note: The top edge of the Ranger wing should be positioned parallel to the style line on the rear side vehicle panels approximately 80 mm above the wing.



104. Position each Ranger wing so they there is an even gap to the mud flap as shown.

PANELS TO RSTB/VEHICLE

Right Ranger wing shown

2-3mm gap along this edge

3-4mm gap along this edge

105. Position each Ranger wing so they sit evenly on the step plate extrusion and there is an even gap to the tube as shown.

106. Tighten the 9 bolts that retain each Ranger wing and the M12 bolts from step 86 to the specified torque.



M8 X 1.25 - 22 Nm.



M12 X 1.75 - 77 Nm.

Note: Check that all clearances are maintained as the fasteners are tightened.

Right diffuser panel shown

107. Position the diffuser panels on either side of the lift up panel as shown.

For vehicles fitted with parking sensors:

108. Connect the parking sensor to the parking sensor loom as the diffuser panels are positioned against the lift up panel.

Right diffuser panel shown

Outside face- M6X20 Hex head bolt and M6x19 black washer.
Inside face - M6 X12 black washer and M6 nyloc nut

109. Attach the diffuser panels to the RSTB using 8 M6x16 button head screws and M6 stainless flat washers. For the outer most screw on each panel, retain using 2 M6X20 hex head bolts, M6x19 black washer and M6x12 black washer and M6 nyloc nut as shown.

Note M6X19 black washer is to be placed on outside of diffuser panel

PANELS TO RSTB/VEHICLE

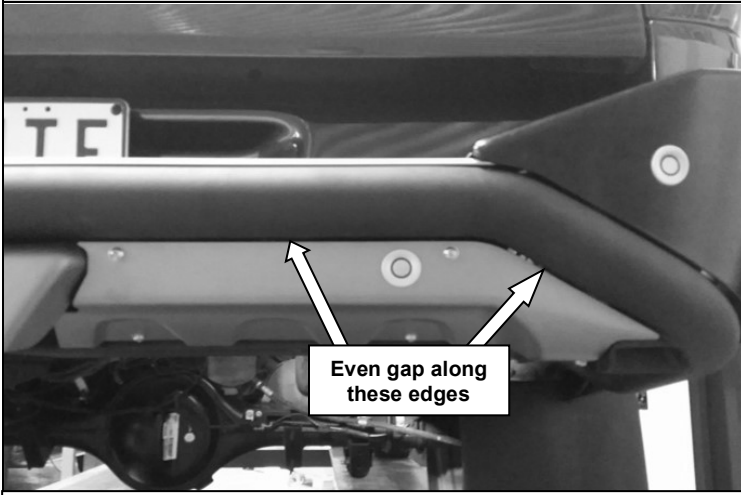

110. Position each diffuser panel so there is an even gap between the panel and the RSTB tube. Tighten fasteners to the specified torque.

 M6 X 1 -9 Nm.

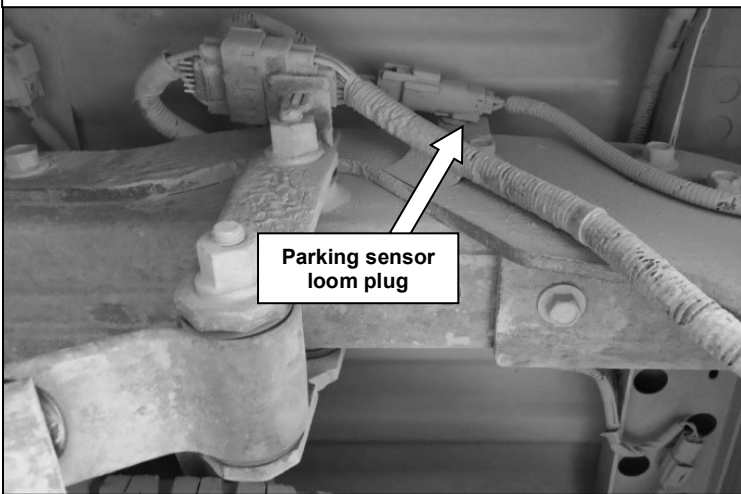

For vehicles fitted with parking sensors:

111. Connect the parking sensor loom to the main vehicle loom using the connector identified in Step 1.



112. Test parking sensors to ensure they are working correctly.
113. Tidy and fasten all wiring using the cable ties provided.

Warning: Make sure all wires are securely fastened away from any hot, sharp or moving surfaces. Do not fasten wiring harness to fuel or brake lines.

114. Test the sensors again as per step 112.

FITTED PRODUCT



FITTED PRODUCT



TRAILER CAMERA PLUG, ANDERSON PLUG AND AIR-LINE FITTING



TRAILER PLUG



HIGH LIFT JACK LOCATION - CORNER OF RSTB



HIGH LIFT JACK LOCATION - SIDE OF WING/ABOVE TUBE

