

Anbauanleitung Streuerhalterung Lada Niva, Taiga und *ab Bild 15 Urban*

Best.-Nr.: 5 – 99100222

AL: 1163 - 02

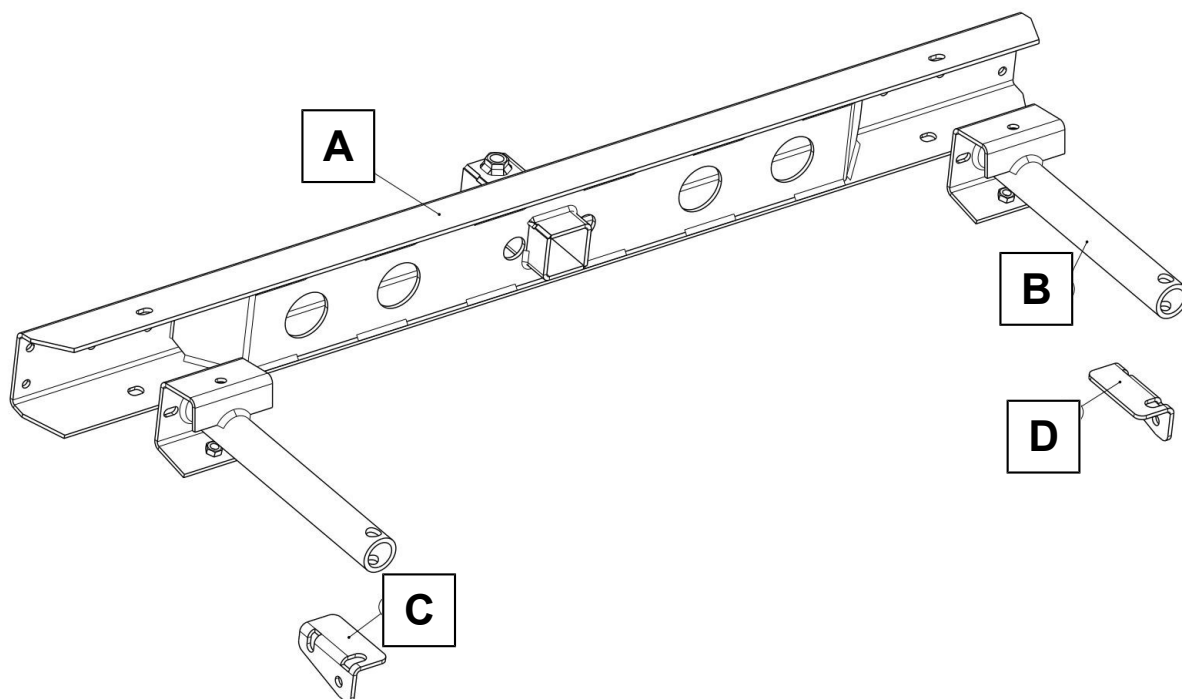

1 x Streueraufnahme (A)

2 x Halter (B)

1 x Winkel rechts (C)

1 x Winkel links (D)

1 x Kunststoffabdeckung 1 –37509

1 x Anleitung AL 1063

1 x Gutachten

1 x Kennzeichnungsaufkleber

8 x Schraube M 10 x 30

12 x Scheibe M10

4 x U-Scheibe M 10 x 30 x 3

8 x Federring M 10

4 x Mutter M 10 selbsts.

4 x Linsenflanschkopfschraube M8 x25

4 x U-Scheibe M8

4 x Federring M8

4 x Mutter M 8

1 x Schraube M 16 x 25



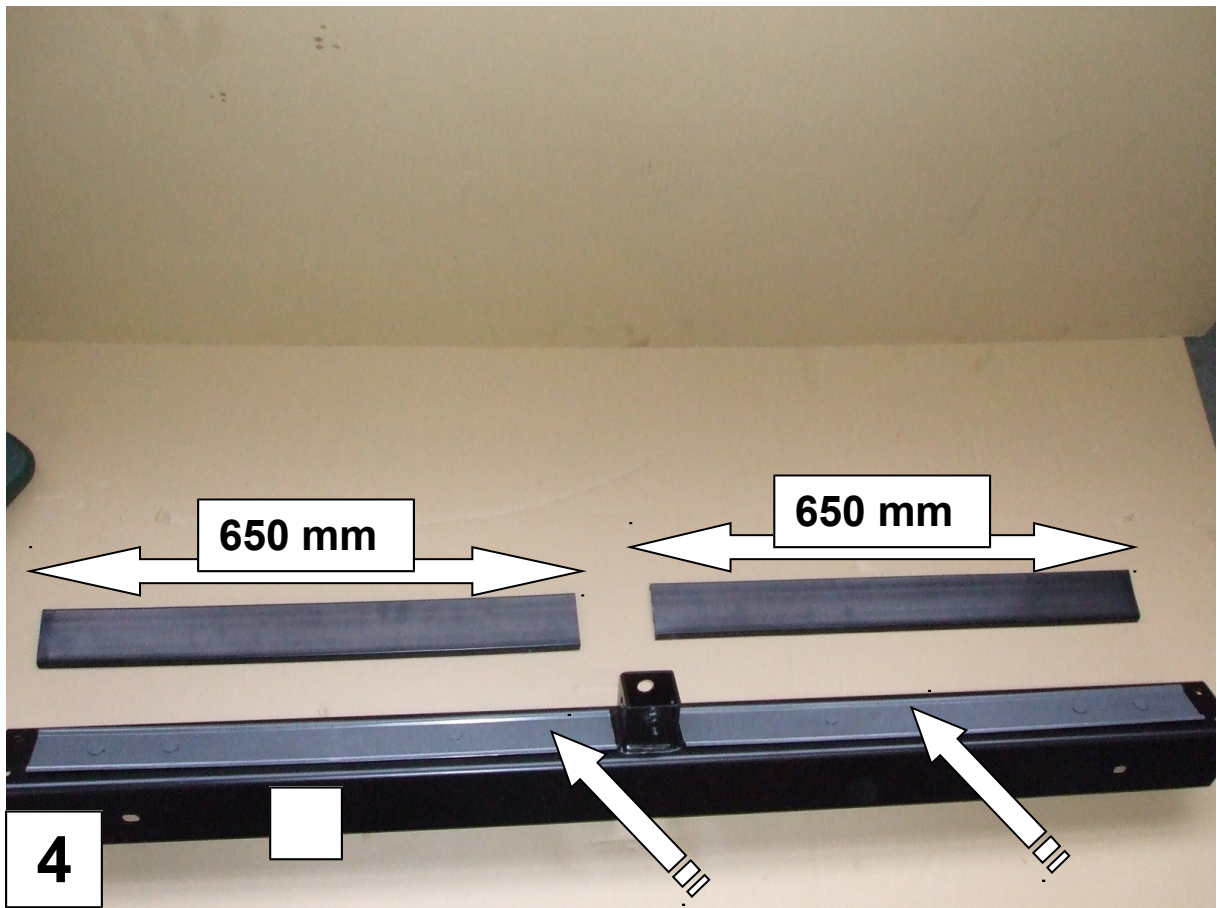
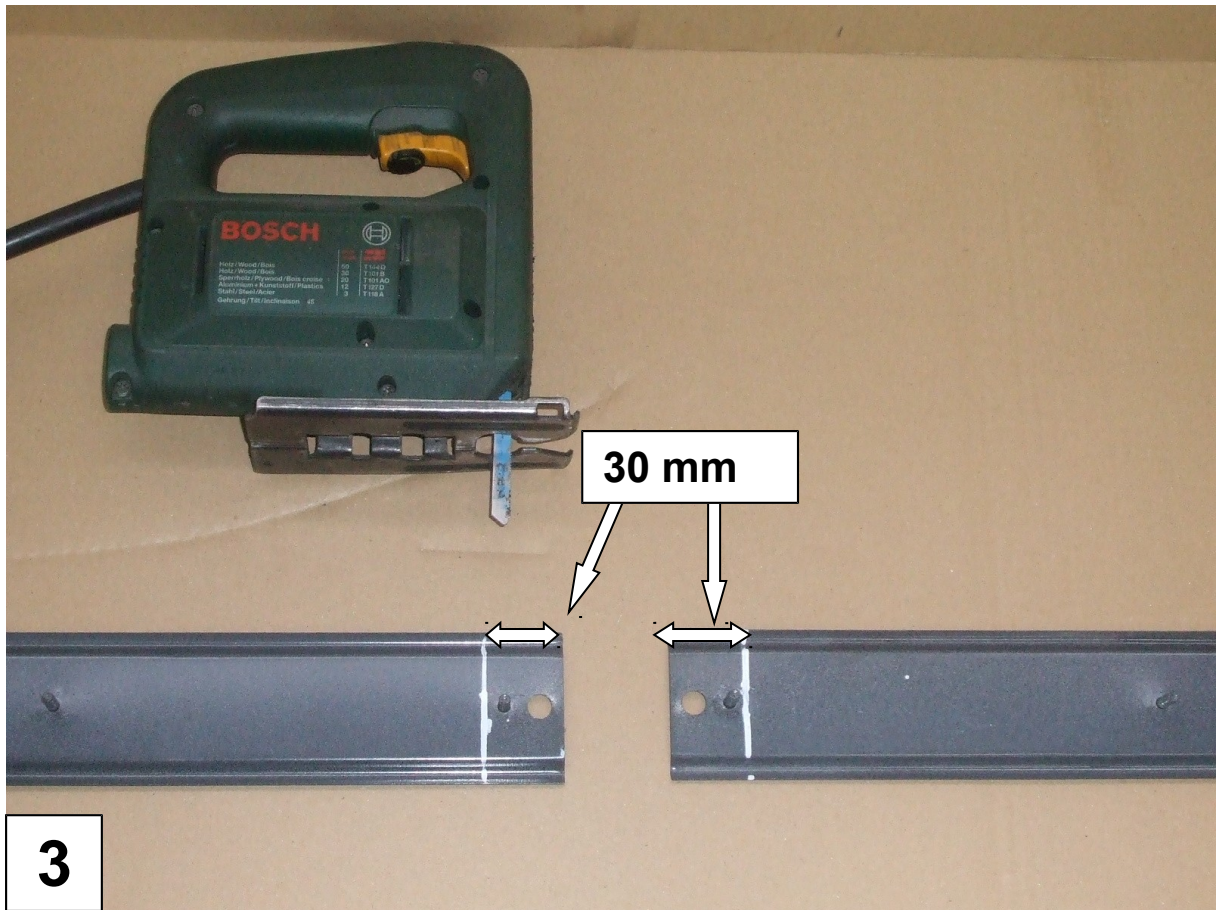

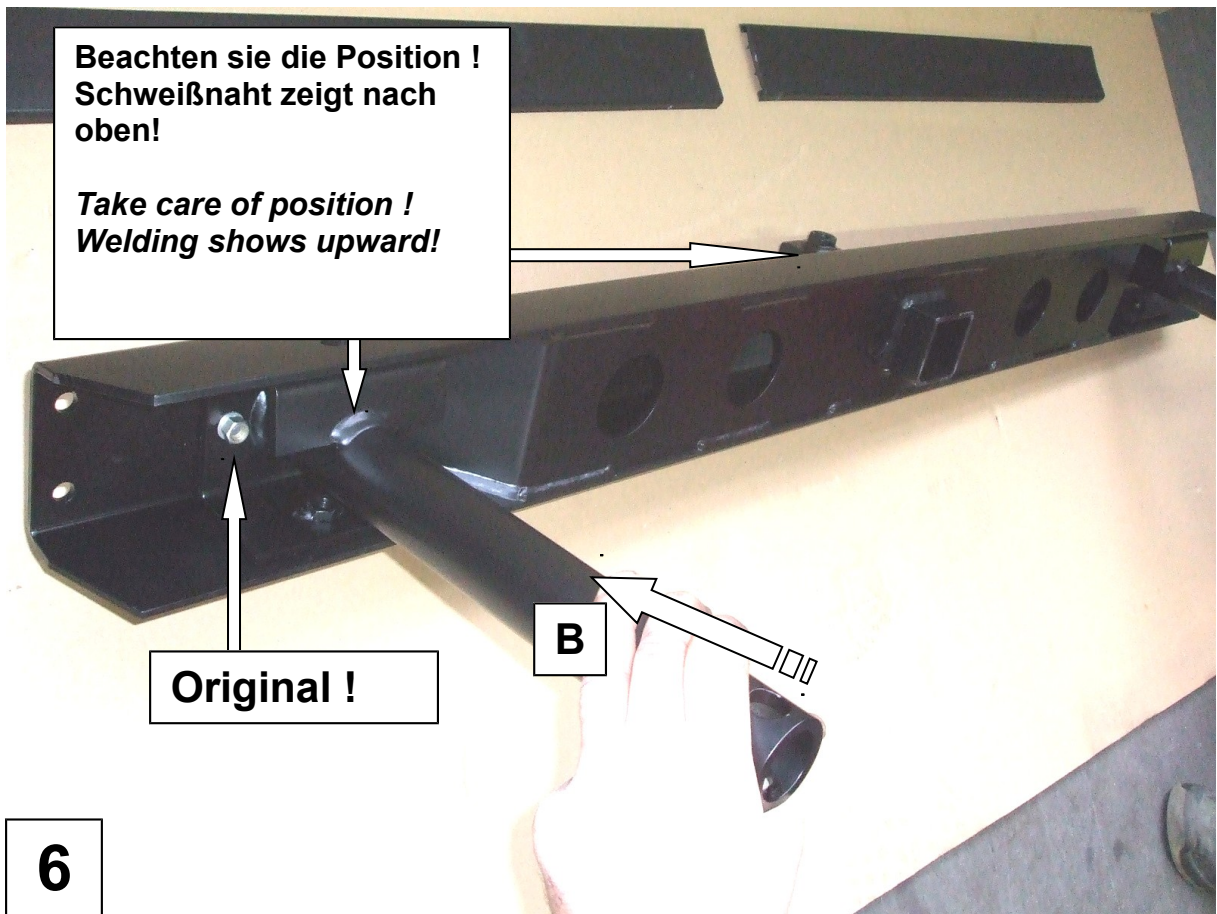

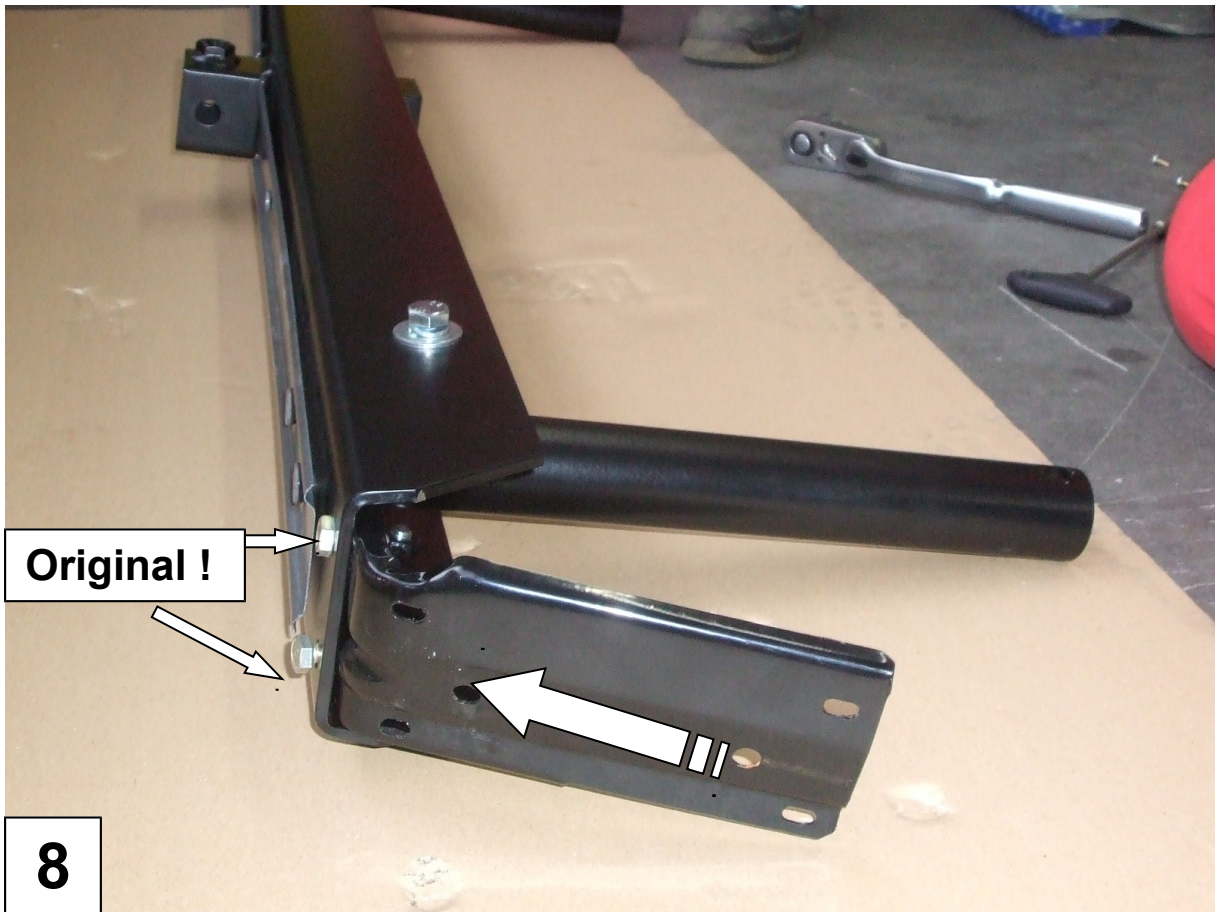
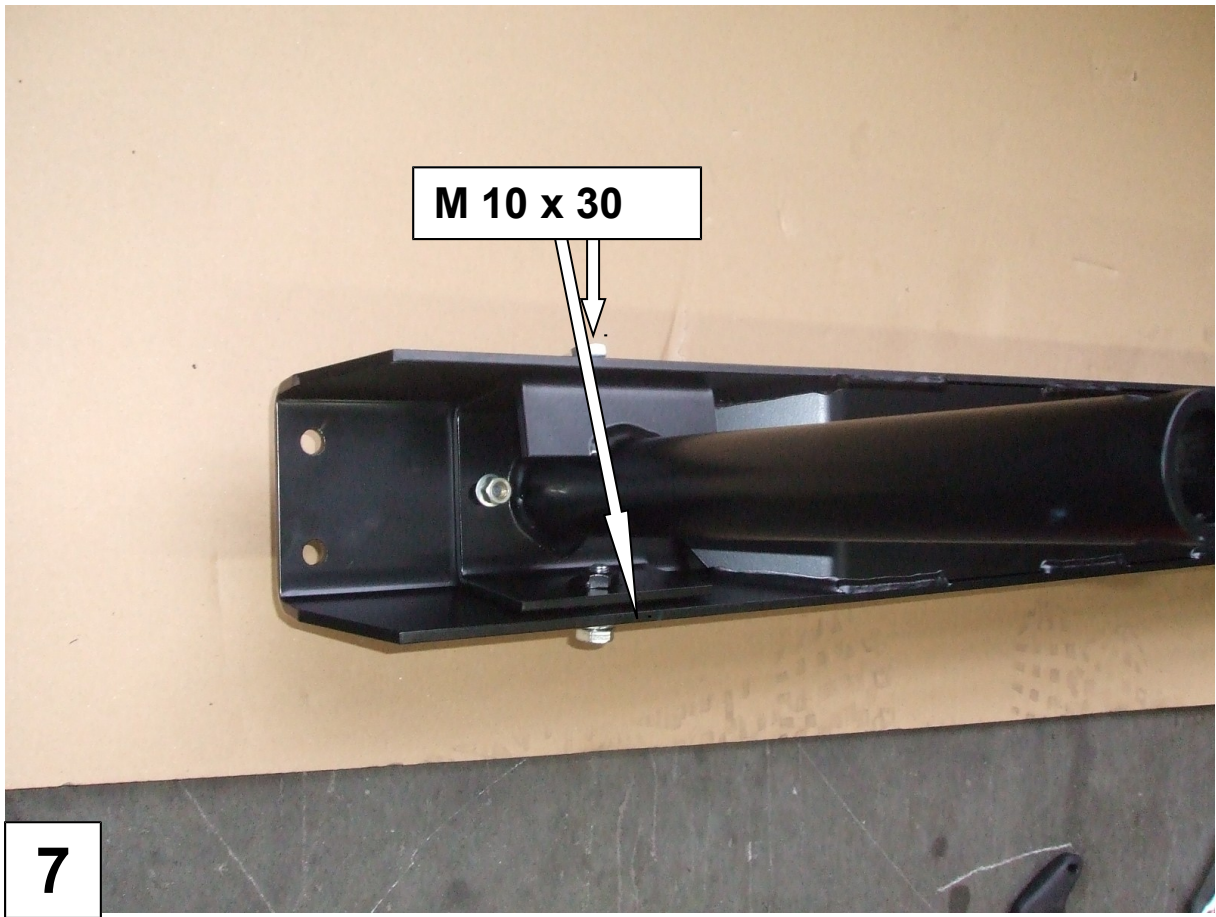





11



12

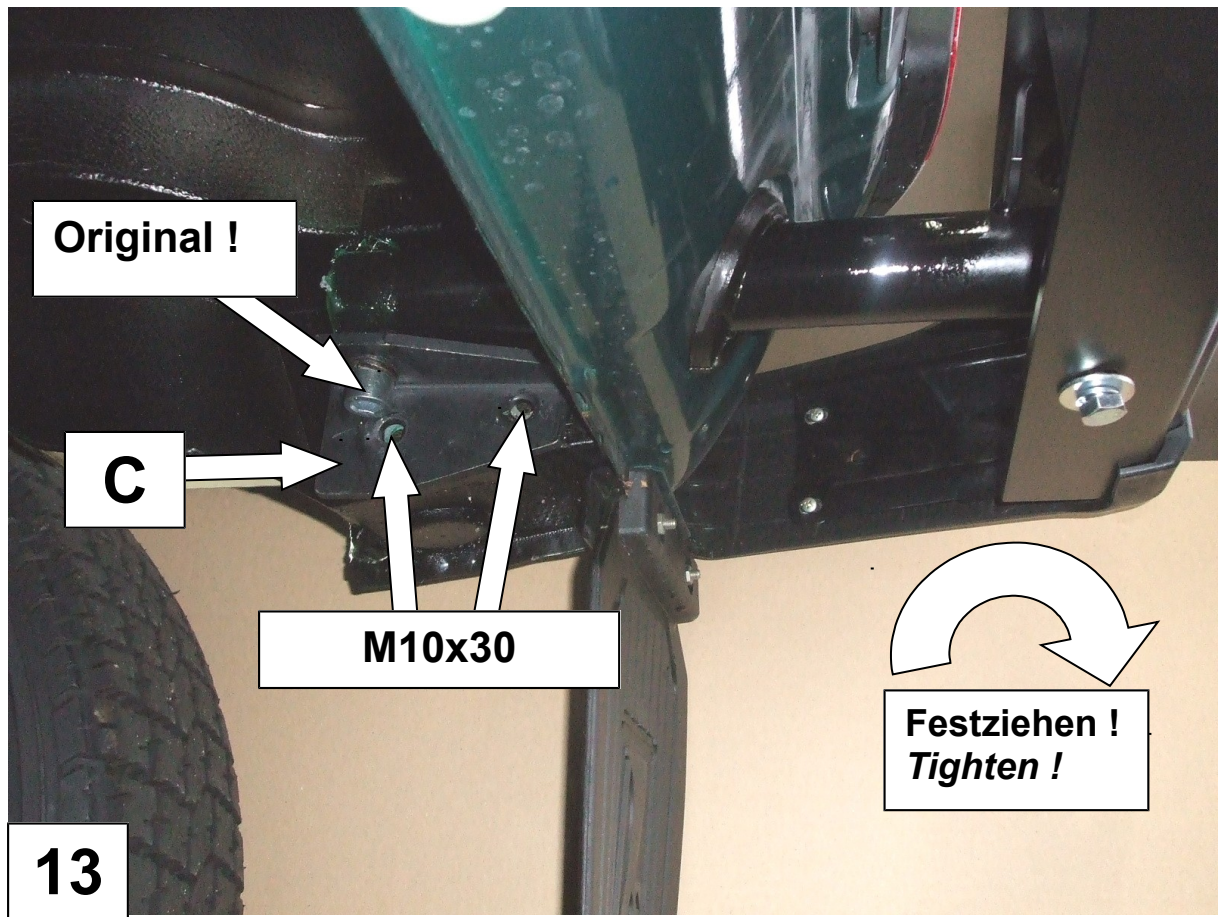

Schritte 15 bis 20 nur URBAN-Modelle



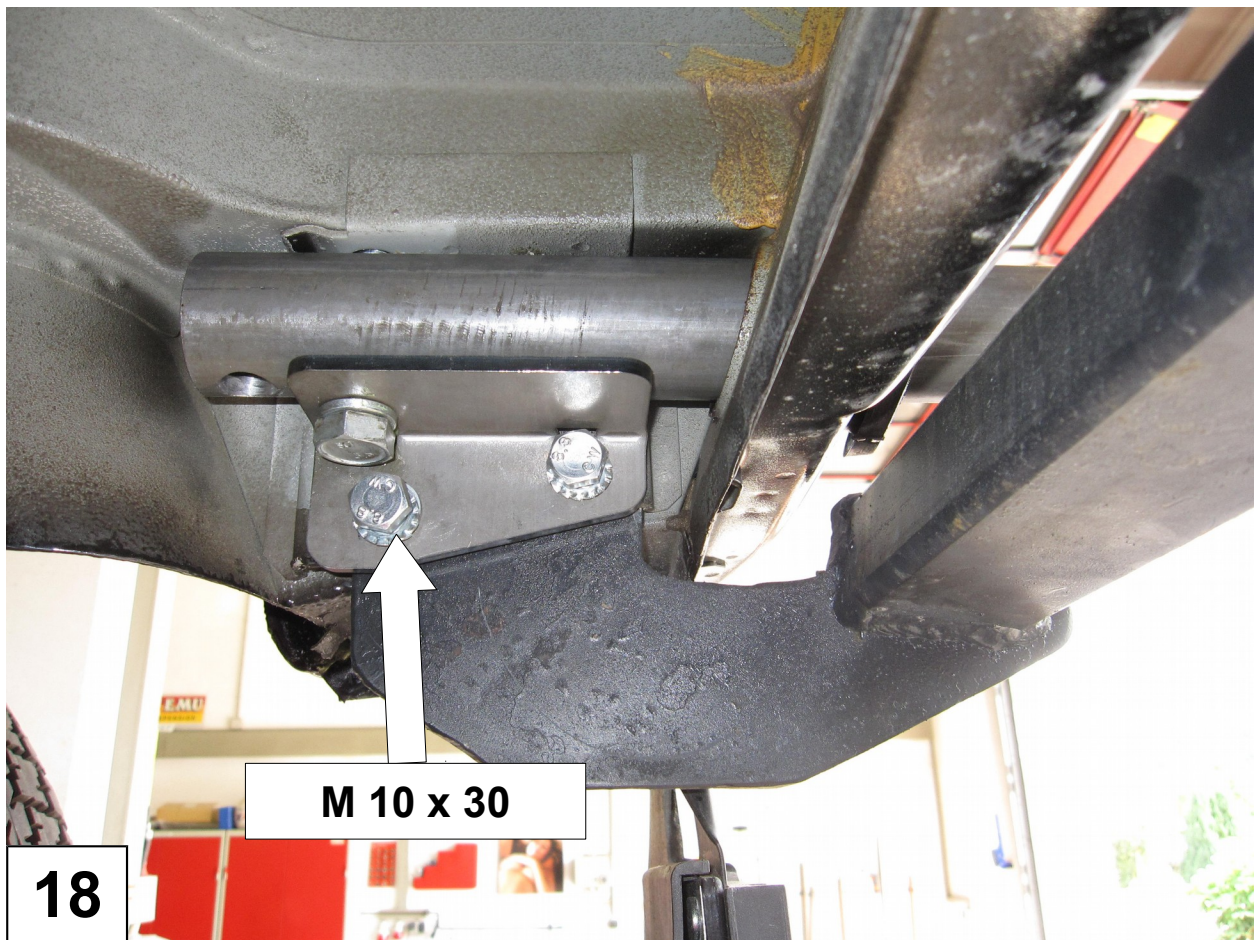
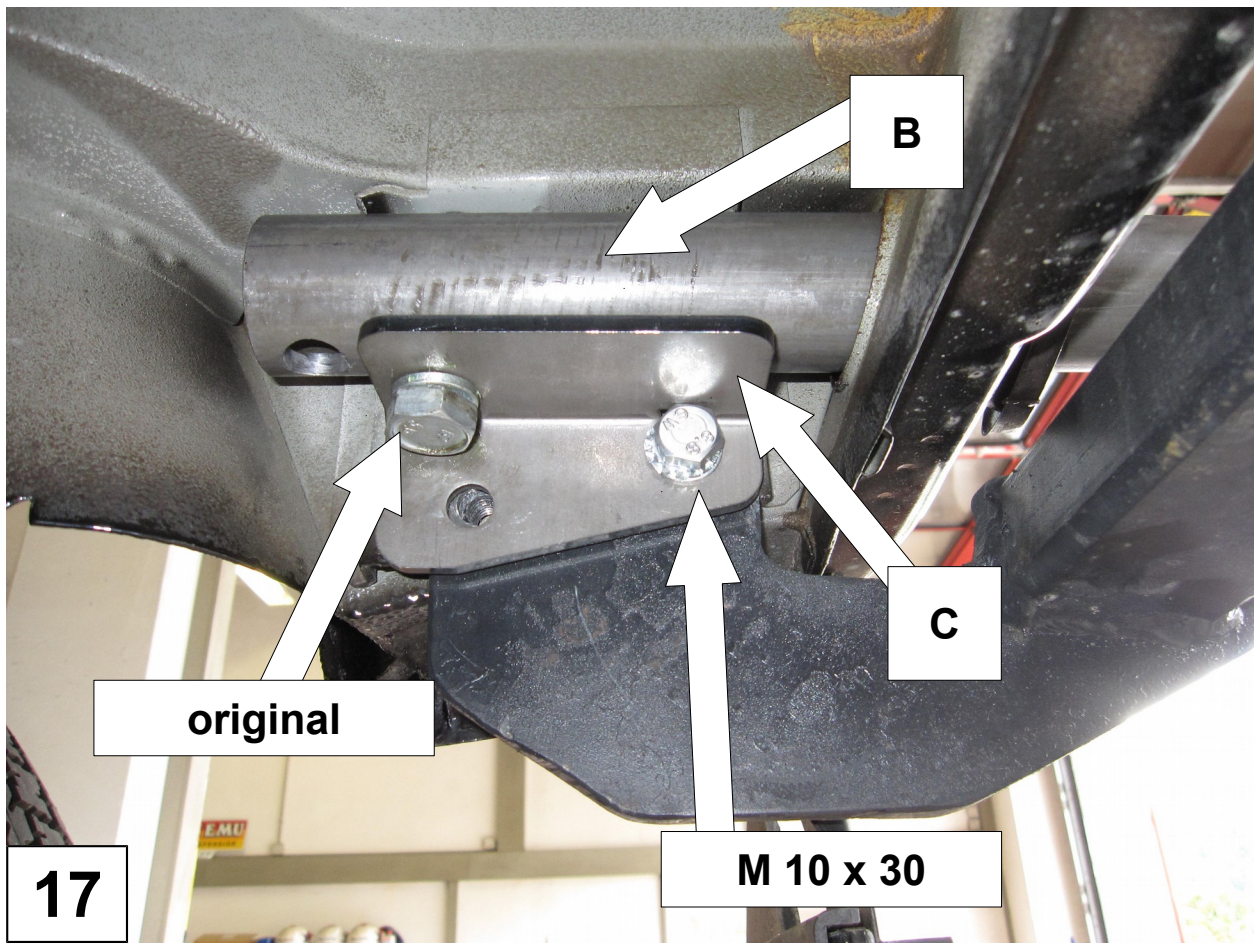



19



20

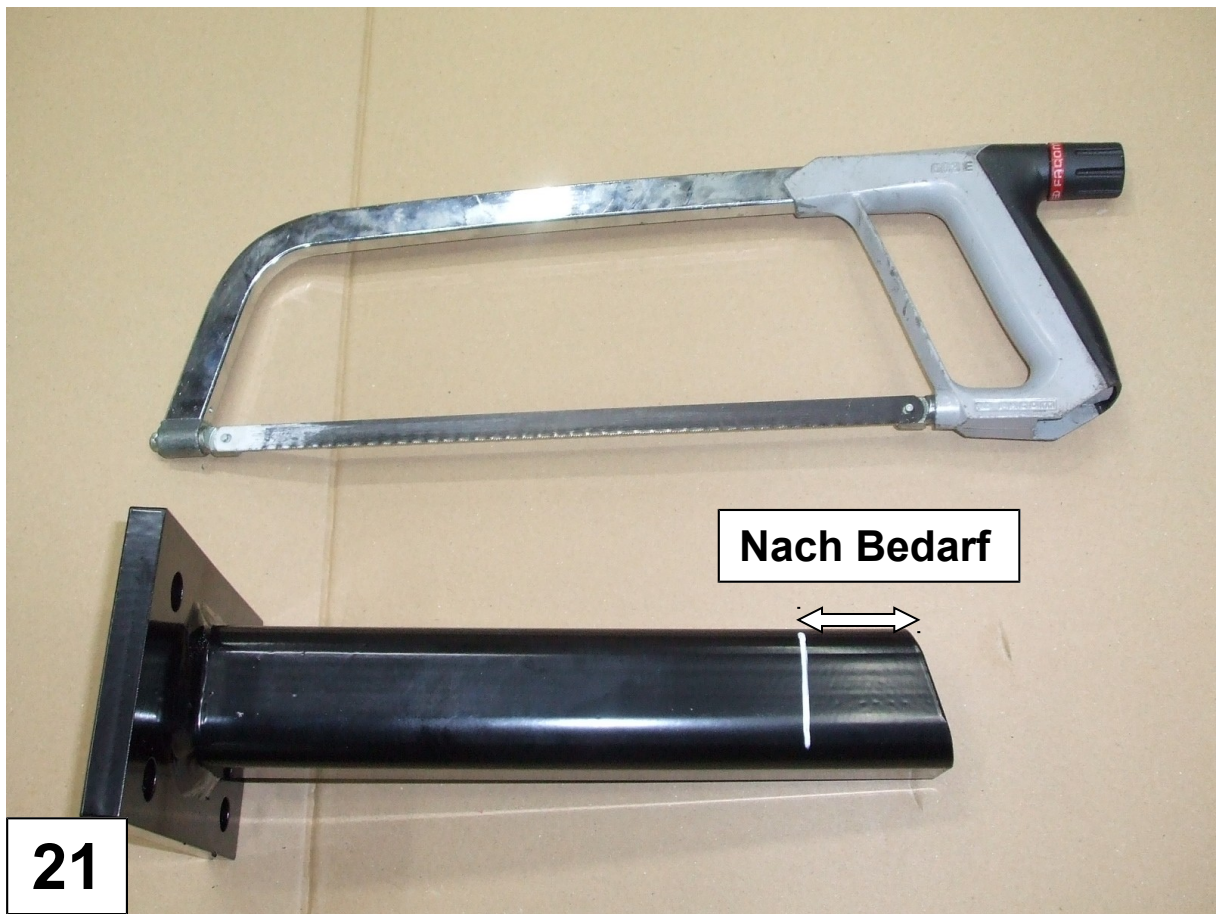



23

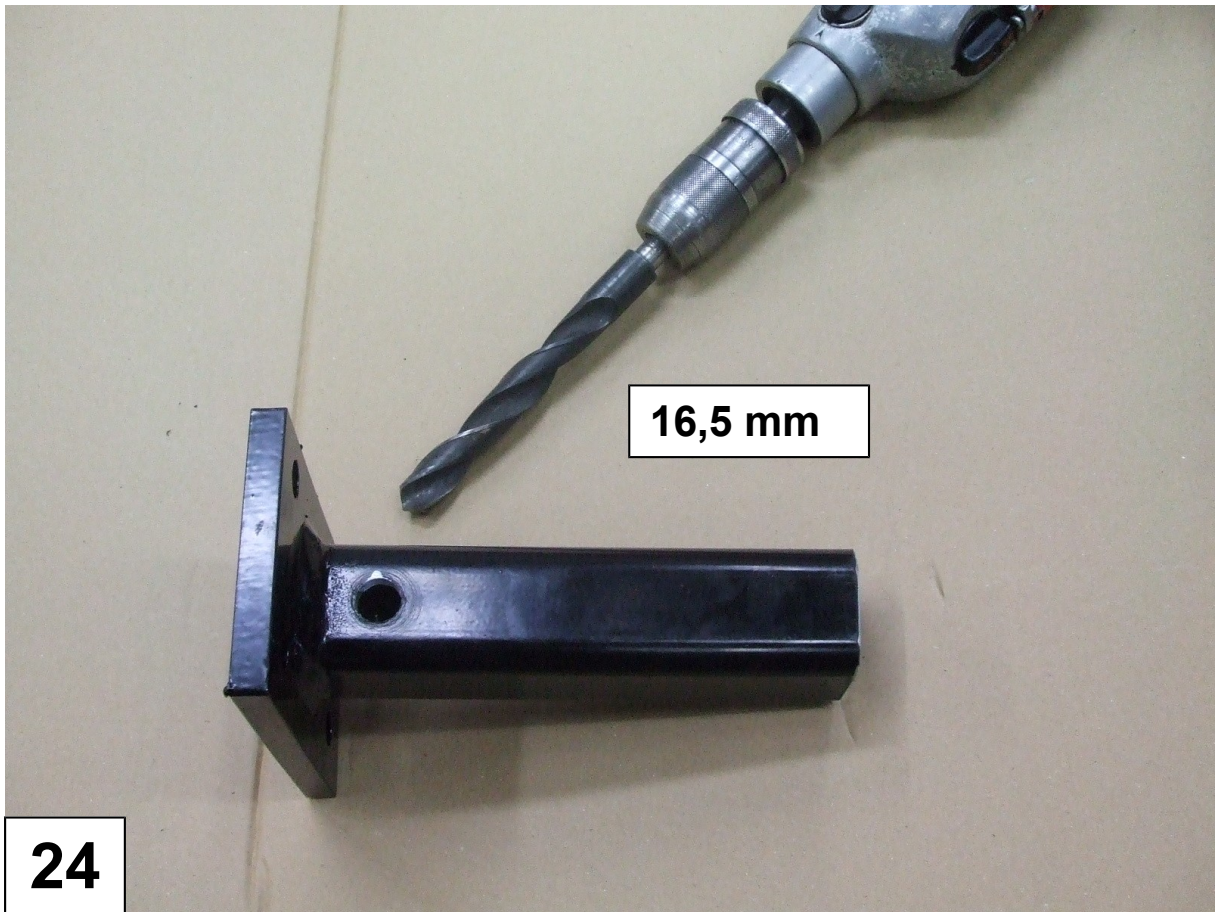

16,5 mm

24



25



26